

COMPRESSOR UNIT

Instruction Manual

C30VR Series

C30VR, C30VRT, C30PVRT, C30MVR, C30MVRT

Export Control Policy

Vacuum pumps that pump nitrogen gas at pumping speed of 15000L/S or more fall under row 2(35) of appended table 1 of Japan's Export Trade Control Order, which is based on international export control regimes. Customers must follow all related rules and regulations such as Foreign Exchange and Foreign Trade Act and take appropriate procedures when exporting or re-exporting those products.

Introduction

Thank you for choosing our products. This instruction manual provides information and precautions on handling, installation, operation, and maintenance of the product.

To ensure proper use of the product, read this instruction manual carefully and keep this manual close at hand so that you can use for reference during operation.

If you have purchased other devices from us, read relevant instruction manuals carefully as well.

1. About the personnel who are involved in handling our products

All personnel involved in handling our products should take general safety training which is officially accepted in the country or region where the product is used. Such personnel are also required to have specialized knowledge, skills or qualifications on electricity, machinery, cargo handling or vacuum. Especially, the personnel should be familiar with handling a cryopump in order to use it safely. We offer training program (paid service) as needed for the customers who are not familiar with the use of cryopumps. Please contact us to join the program.

2. Warranty

2.1 Gratis warranty period and Warranty coverage

【Gratis warranty period】

The period of less than one year after installation in your company or your customer's premises, or a period of less than 18 months (starting from the shipment date) after shipment from ULVAC CRYOGENICS INCORPORATED (hereinafter "UCI"), which is shorter, is selected.

【Coverage】

(1) Failure diagnosis

As a general rule, first diagnosis of failure should be done on site by customer.

However, UCI or our service network can perform this service for an agreed fee upon the customer's request. There will be no charge if the cause of the breakdown is attributed to UCI.

(2) Damage during transportation

When damage by transportation is observed at the time of delivery, the product will be repaired without charge based on the scope of the guarantee expressed in the sales contract.

(3) Breakdown repairs

The cost of repairs, replacements and on-site visits for the failures caused by the reasons as follows shall be borne by the customer regardless the product is within the warranty period.

- ① Inappropriate storage or handling, careless accident, software or hardware design by the customer.
- ② Modifications of the product without consent of UCI.
- ③ Performing maintenance of the product using parts or components which are not approved by UCI, or using the product outside the conditions specified for the product.
- ④ Contamination or corrosion occurred during the use by the customer or customer's customer.
- ⑤ Fire, earthquake, flood, lightning or other natural disasters, environmental pollution, salt damage, hazardous gases, irregular voltage, and/or usage of power source other than specified by UCI.
- ⑥ Other reasons which are regarded to be outside the scope of warranty.
- ⑦ Consumables and/or replacement service.

Since the above services are limited inside Japan, diagnosis of failures, etc may not be performed outside of Japan. If you desire the after sale service abroad, please contact ULVAC CRYOGENICS and consult us for details in advance.

2.2 Exclusion of opportunity loss from warranty liability

Regardless of the gratis warranty term, compensation to opportunity losses incurred to your company or your customers by failures of ULVAC CRYOGENICS products and compensation for damages to products other than ULVAC CRYOGENICS products and other services are not covered under warranty.

2.3 Repair period after production is discontinued

ULVAC CRYOGENICS accepts product repairs for seven years after production of the product is discontinued.

3. Service Form

After the products are delivered, please fill out the following information in the blanks. In the event of a fault, please contact us. Refer to SERVICE NETWORK at the end of this book, or visit our web site at www.ulvac-cryo.com to locate our business base close by.

Cryopump/Super Trap Model	:	_____
Cryopump/Super Trap Serial No.	:	_____
Refrigerator Model	:	_____
Refrigerator Serial No.	:	_____
Compressor Model	:	_____
Compressor Serial No.	:	_____
Temperature controller/Thermal display Model	:	_____
Temperature controller/Thermal display Serial No.	:	_____
Optional Part Model	:	_____
Optional Part Serial No.	:	_____

4. Notes for repair and maintenance requests

We cannot accept your request for repair or maintenance of our products if you refuse to give us information about the presence of the hazardous substance and/or contaminant.

Also, please be aware that we do not accept liability for damages by the contaminant, which might be caused during transportation to our office or the nearest customer support center. To avoid such accident, please pay careful attention to packing of the product

5. In case of breakdown and accident

When breakdown or accident occurs, we may ask for keeping the product on site as it is, or sending it back to us to investigate the cause. In addition, you may be asked to provide information on how it progressed in a specific manner or on the

operating condition. When unidentified failure occurs, please contact our Service Engineering Division or the nearest customer support center. Refer to the SERVICE NETWORK at the end of this book or visit our website at www.ulvac-cryo.com for our contact information.

6. General Precautions

- (1) It is prohibited to duplicate or reprint this instruction manual or any of its parts, disclose or transfer to a third party without written permission from ULVAC CRYOGENICS.
- (2) Information in this document is subject to change without notice along with the specification change or the improvement of the product.
- (3) If you have any questions or comments on this document, please contact us.

Safety Icons and Texts

Our products have been designed to provide extremely safe and dependable operation when properly used. Following safety icons indicate cautions, warnings or danger that must be observed during normal operation and when servicing them.

**WARNING**

A warning describes safety hazards or unsafe practices which could result in severe injury or loss of life.

**CAUTION**

A caution describes safety hazards or unsafe practices which could result in personal injury or equipment damage.

**Toxic gas or chemicals used.**

There is a risk of severe injury upon contact.

**Corrosive chemicals used.**

There is a risk of severe injury upon contact.

**Flammable gas used.**

There is a danger of fire or burn injury.

**Explosive gas used.**

There is a risk of fire or explosion.

**Hazardous voltage.**

Electric shock may cause severe injury or loss of life.

**Hot heating part present.**

There is a risk of burn injury.

This page intentionally left blank

Table of Contents

Compressor unit Safety Instructions	S-1
Disposal Considerations	IW-1
Section 1. C30VR Compressor Description	1-1
1.1 Introduction	1-1
1.2 Compressor model descriptions	1-1
1.3 Terminology	1-2
1.4 Cryopump system documents	1-2
1.5 Roles of compressor in cryopump system	1-2
1.6 Compressor specifications	1-3
1.7 Component descriptions	1-7
1.8 CRYO-U® cryopump multiple installation	1-12
1.9 Compressor with inverter for refrigerator	1-13
Section 2 Considerations before Installation	2-1
2.1 Combination of cryopump and compressor	2-1
2.2 Installation environment requirements	2-1
2.3 Wiring requirements	2-2
2.4 Cooling water requirements	2-4
2.5 Length of cables and flexible hoses	2-7
2.6 Remote functions	2-7
Section 3 Unpacking and Inspection	3-1
3.1 Compressor carton	3-1
3.2 Shipping carton inspection	3-1
3.3 Unpacking	3-2
3.4 Carton contents	3-3
3.5 Inspection of the compressor and accessories	3-4
3.6 Flexible hoses and specifications	3-4
Section 4 Equipment Installation, Piping, and Wiring	4-1
4.1 Before installation	4-1
4.2 Connecting cooling water piping	4-2
4.3 Connecting and disconnecting helium flexible hoses	4-2
4.4 Single cryopump installation	4-4
4.5 Multiple cryopump installation	4-5
4.6 Electrical connections	4-7
4.7 Wire routing for compressor and other equipments	4-13
Section 5 Operation	5-1
5.1 Verification of helium static pressure	5-1
5.2 Compressor operation	5-2
5.3 Inspection after replacing helium circulation components	5-4
5.4 Precautions for when compressor is not in operation	5-5
5.5 Maintenance operation for a compressor suspended for a long period	5-5

Section 6	Wiring and Piping Removal and Storage	6-1
6.1	Removal of wiring and piping and displacement of compressor	6-1
6.2	Maintenance in storage	6-2
Section 7	Maintenance	7-1
7.1	Scheduled maintenance	7-1
7.2	Replacement of adsorber	7-1
7.3	Adjusting system helium pressure	7-5
7.4	Regular maintenance of helium lines, cooling water piping and electrical wiring	7-10
7.5	Maintenance parts	7-10
Section 8	Troubleshooting	8-1
8.1	Problem types	8-1
8.2	Troubleshooting procedures	8-2
8.3	Alarm code descriptions	8-4
Appendix A	Operating Log	A-1
Appendix B	Combination of C30V R Compressor Unit and Cryopump/Supertrap	B-1
Appendix C	C30V R Schematic Diagram	C-1
Appendix D	C30V R Compressor Flow Diagram	D-1

List of Figures

Figure 1-1	C30VR Compressor models	1-1
Figure 1-2	C30VR External view	1-3
Figure 1-3	C30VR Front panel (Part)	1-4
Figure 1-4	C30MVR Front panel (Part)	1-4
Figure 1-5	C30VR Compressor dimensions	1-5
Figure 1-6	Compressor front view	1-7
Figure 1-7	Compressor rear view	1-8
Figure 1-8	Anchor bolts mounting positions (example)	1-9
Figure 1-9	Cryopump installation with C30MVR compressor	1-12
Figure 1-10	C30VR compressor with inverter	1-13
Figure 2-1	Required space for compressor installation (scale: mm) and levelness	2-2
Figure 2-2	Equipment-side power circuit	2-3
Figure 2-3	Cooling water flow rate, water supply temperature, and water pressure loss	2-5
Figure 2-4	Cooling water flow rate, water supply temperature, and water pressure loss	2-6
Figure 2-5	Remote input interface circuit	2-8
Figure 2-6	Remote output interface circuit	2-8
Figure 2-7	Timing chart for Alternate operating mode with two refrigerators	2-12
Figure 2-8	Timing chart for Momentary operating mode with two refrigerators	2-12
Figure 2-9	Signal delay when powered on (In Alternate operating mode)	2-13
Figure 2-10	Signal delay when the time period from a stop to a restart is short	2-14
Figure 2-11	Timing chart of C30VR when a short power interruption occurs	2-14

Figure 3-1	Appearance of compressor carton	3-1
Figure 3-2	Remove cardboard and insert forks underneath the compressor	3-3
Figure 4-1	Installation procedure	4-1
Figure 4-2	Tighten with hands first	4-3
Figure 4-3	Tighten with two spanners	4-3
Figure 4-4	Connecting and disconnecting helium flexible hoses to compressor and refrigerator	4-4
Figure 4-5	Connections of the compressor and single cryopump	4-5
Figure 4-6	Connections of the compressor and multiple cryopumps	4-6
Figure 4-7	Connecting input power cable connector	4-8
Figure 4-8	Remote connector pin assignments for C30VR	4-8
Figure 4-9	Remote connector pin assignments for C30MVR	4-9
Figure 4-10	(C30VR) "Alternate operating mode" wiring example for Single cryopump operation	4-9
Figure 4-11	(C30MVR) "Momentary operating mode" wiring example for Multiple cryopumps operation	4-11
Figure 4-12	Connector parts descriptions	4-12
Figure 4-13	Cut length of insulation coating	4-12
Figure 4-14	Fix with set screw	4-12
Figure 5-1	Helium static pressure and ambient temperature	5-2
Figure 5-2	Ready for operation	5-3
Figure 5-3	Reversed phase or open phase	5-3
Figure 5-4	Status display during C30MVR operation	5-3
Figure 7-1	Remove two nuts from the helium gas connectors	7-3
Figure 7-2	Remove all seven screws from the rear panel	7-3
Figure 7-3	Remove the rear panel	7-3
Figure 7-4	Remove self-sealing coupling	7-3
Figure 7-5	Connecting and disconnecting self-sealing coupling with two spanners	7-4
Figure 7-6	Remove adsorber mounting bolt	7-4
Figure 7-7	Slide adsorber outward	7-4
Figure 7-8	Locations of front panel screws and components inside the compressor	7-7
Figure 7-9	Items for adding helium gas to the compressor	7-8
Figure 8-1	Alarm status table	8-1
Figure 8-2	Alarm status code table	8-2
Figure C-1	C30VR schematic diagram	C-2
Figure C-2	C30MVR schematic diagram	C-3
Figure C-3	C30VRT and C30PVRT schematic diagram	C-4
Figure C-4	C30MVRT schematic diagram	C-5
Figure D-1	Compressor flow diagram	D-2

List of Tables

Table 1-1	C30VR Compressor models	1-2
Table 1-2	Compressor weight	1-5
Table 1-3	Power supply rating	1-6
Table 1-4	Cooling water requirements	1-6
Table 1-5	Installation environment and operation requirements	1-6
Table 1-6	Electromagnetic environment resistance characteristics	1-7
Table 2-1	Input power cable specifications	2-2
Table 2-2	Control and signal wire gauges	2-3
Table 2-3	Recommended cooling water for compressor	2-4
Table 2-4	Standard cables and flexible hoses	2-7
Table 2-5	Remote interface specifications	2-7
Table 2-6	Remote interface signals	2-9
Table 3-1	Carton contents	3-3
Table 3-2	Optional parts	3-3
Table 3-3	Flexible hose specifications	3-4
Table 5-1	Supply line helium pressure during operation	5-4
Table 7-1	Scheduled maintenance	7-1
Table 7-2	Equipment requirement for adding helium gas	7-7
Table 7-3	Maintenance parts	7-10
Table 8-1	List of troubleshooting before operation	8-2
Table 8-2	List of troubleshooting during operation	8-3
Table A-1	Operating log	A-1
Table B-1	Combination of C30VR series compressor and cryopump/supertrap	B-1
Table C-1	Differences on devices between compressor unit models	C-1

Compressor Unit Safety Instructions

Read this manual and follow these safety guidelines before installing, operating, or servicing the compressor unit.

1. Do not overfill helium gas



Our cryopump and Super Trap refrigerator systems make a refrigeration cycle by circulating high pressure helium gas. Filling helium gas of more than appropriate amount does not improve refrigeration capacity appreciably. Instead, if too much helium gas is added and helium pressure becomes higher than appropriate, helium will blow out from the pressure relief valve, which can be a cause of helium leak by dust being stuck in the sheet. This may even overload the compressor motor.

Never charge helium gas more than specified in this book.

2. Adding Helium Gas and Charging Equipment

When charging helium gas or performing helium line decontamination, please read the "Maintenance" section carefully and follow the instruction.

Use regulators, charging hoses, or adopters that can be used at the pressure of 2.0MPaG or higher when performing the above work

3. Do not startup/shutdown frequently

Do not startup/shutdown the compressor unit frequently.

The number of startup and shutdown of the compressor motor must be less than 6 times per hour and ON or OFF condition must be maintained for at least 3 minutes. Frequent shutdowns and startups may shorten the insulation life of a compressor motor and may lead to failure. When operating multiple refrigerators, startup/shutdown of the refrigerator motors must also be less than 6 times.

Do not use startup and shutdown of a compressor unit to control the temperature of the Super Trap.

Please contact us when controlling the temperature of super trap is required.

4. Disposal of used adsorber



Ensure to discharge helium gas and remove either side of the self-sealing couplings from the used adsorber before disposing of it.

Ensure to discharge helium gas and remove either side of the self-sealing couplings from used adsorber before disposing.

When the refrigerator system is not in operation, the helium gas pressure inside the adsorber is as high as the fill pressure of the compressor. Disposing the adsorber with helium gas inside may cause accidents. For example, if the adsorber was thrown in a burner reactor without discharging helium gas by mistake, the inside pressure of the adsorber would rise as the inside temperature rises and it may explode. If the adsorber was pressed with helium gas still inside, it may also cause an explosion. Refer to “Disposal Considerations” for more information.

Use appropriate charging adaptor to remove helium gas safely.

5. Electrical wiring connections

- Power supply voltage must be kept within the allowable range. Applying more than the allowed voltage may damage the equipment.
- Refer to “Section 1 Table1-3 Power supply rating” to install a ground-fault circuit interrupter.
- Grounding conductor (earth wire) must be connected (D class grounding (with the ground resistance of 100Ω)).
- Connect the refrigerator cable and remote cables (signal lines) to the compressor before connecting the compressor to the power supply. These wiring connections must not be done when the compressor is powered on. It could lead to a serious accident such as electric shock and/or damage to the equipment.
- Follow recommended sizes for wires and cables.
- Power lines and signal lines must be wired at least 10cm separate from one another.

6. Cooling water

If there is a water leak, there is a danger of electric shock. Ensure there is no water leak from the cooling water piping. If the water pressure is too high, a leak may occur in the cooling water line inside the compressor unit. Adjust and control the cooling water supply pressure to maintain an allowable upper limit (lower than 0.7MPaG) indicated in “Section 1 Table 1-4 Cooling water requirements”

If water stain or some products accumulate in the water line inside the heat exchanger, heat exchange effectiveness will be significantly reduced and helium gas temperature will rise, this may shut down the compressor unit.

We employ the cooling water quality management standard of the Japan Refrigeration and Air Conditioning Industry Association as a standard value of water quality for compressor units. Please refer to “Section 2 Table 2-3 Recommended cooling water for compressor”.

7. Compressor unit ambient conditions

The upper limit of the compressor operating ambient temperature is 35°C (38°C except for C30VR series). Do not use the compressor in unsuitable environments such as dusty, highly humid environments and/or places that are affected by strong electromagnetic waves. (Refer to “Section 1 Table 1-5 Installation environment and operation requirements” and “Table 1-6 Electromagnetic environment resistance characteristics”). Keep electric terminals free from dust to avoid electrical leakage and/or a short circuit.

8. Maintenance precautions



1. Installation and maintenance of the product must be done by personnel in charge of the equipment or servicing who are familiar with the product structure and risk associated with the operation of the compressor.
2. Input power supply must be shut off before opening the cover of the compressor to avoid the risk of electrical shock.

Also, parts of inside the compressor unit are still hot just after the compressor has been stopped. Wait at least 15 minutes to open the cover to avoid the risk of burns.

9. Contact us immediately when the self-sealing coupling is loosened.



When working with a self-sealing coupling, the connection may be accidentally loosened or loosened by co-rotation. In such cases, the refrigerator may encounter faults due to helium leakage or air invasion, resulting in serious failure such as abnormal noise or refrigerator motor malfunction.

At the time of shipment of our products, we conduct the inspection to ensure the connection of self-sealing coupling is appropriate and paste a sealing sticker. The sealing stickers are added to our refrigerators, compressor units, flexible hoses, branch pipes and straight pipe units.

Contact us when the self-sealing coupling is loosened or removed by accident. Servicing for trouble is out of warranty if it occurs while the sealing sticker is not in the original state. The sealing sticker is located inside the panel of the compressor unit.

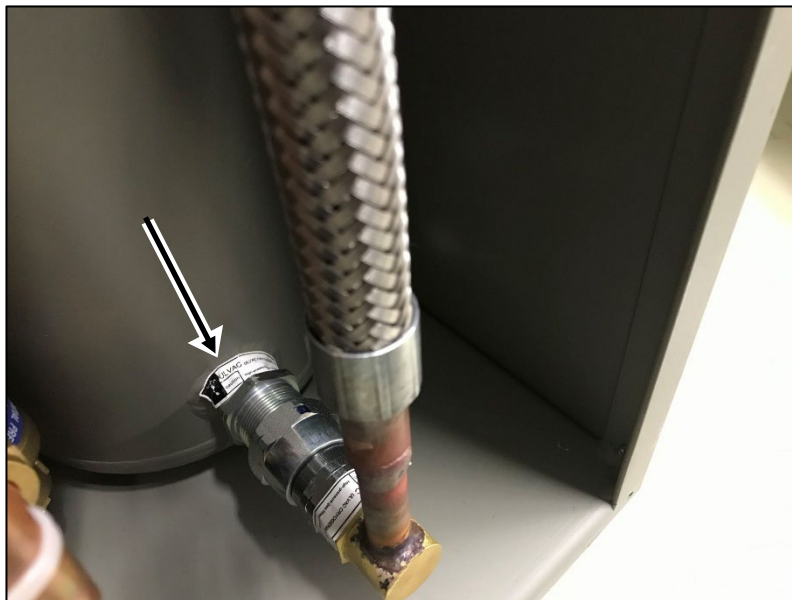








Figure Example of a sealing sticker

Disposal Considerations

Disposal of our products must be done in accordance with applicable national and local laws and regulations.

				WARNING
<p>The cryopumps or cryocoolers may contain residue of hazardous substances resulting from actual use. Contact your safety supervisor and follow the instructions to remove such toxic substances before disposing</p>				

		WARNING
<p>Do not disassemble, pressurize, heat up a compressor unit, or throw it into fire. Such actions may lead to explosion of the adsorber inside the compressor unit. For safe disposal of an adsorber, follow the procedures below.</p> <ol style="list-style-type: none">(1) Remove high pressure helium gas inside the adsorber to reduce the internal pressure to the level of ambient atmospheric pressure. To do so safely, use tools appropriate to the adsorber coupling such as our charging adaptor (for cryocooler maintenance).(2) Remove the coupling to make it visible that the adsorber has been depressurized before proceeding to the next step.		

We provide Safety Data Sheet (called SDS) of our products upon your request.

Please contact us if necessary.

This page intentionally left blank.

Section 1. C30VR Compressor Description

1.1	Introduction	1-1
1.2	Compressor model descriptions	1-1
1.3	Terminology.....	1-2
1.4	Cryopump system documents	1-2
1.5	Roles of compressor in cryopump system.....	1-2
1.6	Compressor specifications.....	1-3
1.7	Component descriptions	1-7
1.8	CRYO-U® cryopump multiple installation.....	1-12
1.9	Compressor with inverter for refrigerator	1-13

1.1 Introduction

C30VR is the successor of C30V/C30MV/C30PV, a compressor for cryopump systems and it is highly compatible with these conventional compressors.

NOTE: All personnel involved in installation, operation, adjustment, maintenance and servicing must be familiar with the contents of both the C30VR compressor and related components.
To ensure safe, reliable system performance, read this manual as well as other relevant manuals completely to gain a thorough understanding before beginning work.

1.2 Compressor model descriptions

C30VR has several models as below (See Figure1-1, Table1-1) differentiated by model designations. The model designation is written on the shipping list and nameplate of the compressor except for optional products.

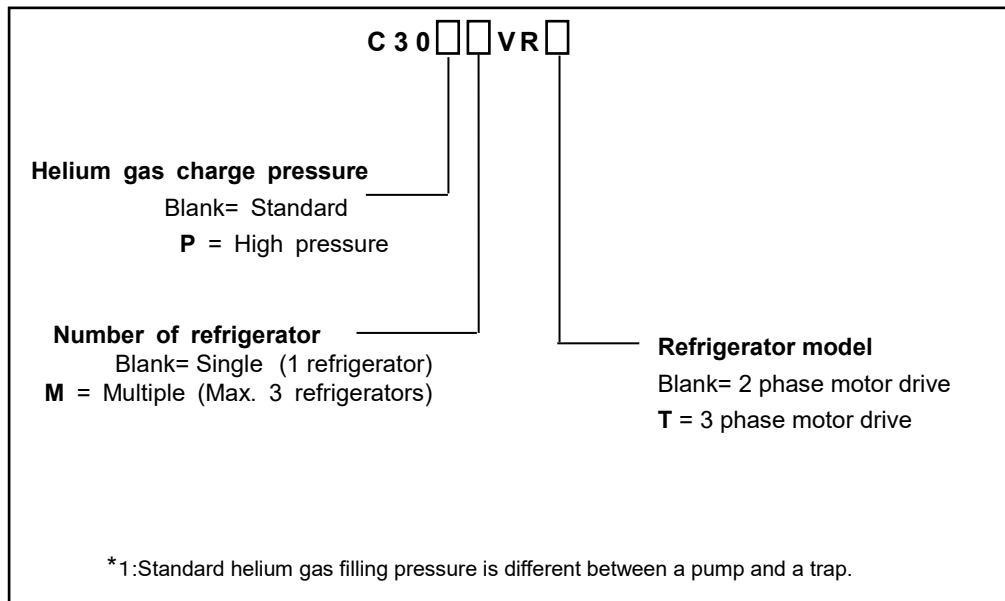


Figure 1-1 C30VR Compressor models

Table 1-1 C30VR Compressor models

Compressor model	Number of connectable refrigerator	Refrigerator motor	Specification* ¹	Power consumption 50/60Hz
C30VR	1 (single)	2 phase	standard	5.0/6.0kW
C30VRT		3 phase	standard	5.0/6.0kW
C30PVRT			For R80RTrefrigerator	5.7/7.5kW
C30MVR	Up to 3 (multiple)	2 phase	standard	5.0/6.0kW
C30MVRT		3 phase	standard	5.0/6.0kW

*1 Refer to Appendix B for detailed specifications of connectable pumps and refrigerators.

1.3 Terminology

1) This manual provides instructions for C30VR, C30MVR, C30VRT, C30PVRT, C30MVRT, however “**C30VR**” is used as the term covers all models unless a model needs to be differentiated from other models.

Within the term “**C30VR**”, when it is needed to differentiate multi-compressor and single-compressor, “**C30MVR**” is used for all compressor models that can be connected to multiple refrigerators and “**C30VR**” is used for all compressor models that can be connected only to single refrigerator.

2) There are two types of cryopump. One is the CRYO-U® series cryopump which can pump almost any gas and the other is CRYO-T super trap series which is specialized for pumping water. Unless otherwise indicated, the term “cryopump” refers to both types.

3) The term “Compressor” means compressor assembly. The helium compressor which is a part of the assembly is sometimes called “compressor pump” to differentiate from the assembly.

4) The cryopump system does not start by itself but by the command from a customer’s equipment or high-order system. Thus, the cryopump system is one of the components of a customer’s whole system.

Henceforth, an interface between the cryopump system and a customer’s equipment or high-order system is called “equipment-side” for short.

1.4 Cryopump system documents

The cryopump system documents basically consist of two manuals: the cryopump manual and the compressor manual. They are shipped with the purchased products.

Accessories for the system and manuals for optional devices are enclosed depending on the product specifications that the customer orders.

1.5 Roles of compressor in cryopump system

The cryopump system consists of a cryopump and a compressor and is capable of condensing and adsorbing almost all kinds of gas molecule inside the pump. Thus clean high vacuum and ultra high vacuum can be easily created.

The Compressor provides high pressure helium gas for the cryopump refrigerator through helium supply flexible hose. Refrigerator expands high pressure helium gas and provides

cooling to condense and adsorb gas molecule inside the pump. Lowered pressure helium gas returns to the compressor through the helium return flexible hose. The compressor compresses the low pressure helium gas to turn it into high pressure gas and supply it to the cryopump refrigerator again.

This helium line is a closed circuit and helium gas is cycled to use. Therefore refilling helium gas is not necessary for long time.

Helium gas is compressed in a highly-reliable oil injection type helium compressor. Helium gas recovers its purity as it flows through an oil separator and an adsorber, where contaminants are removed.

It is necessary to check the elapsed time of operation and replace adsorber regularly to maintain refrigeration capacity as well as prevent breakdown of the refrigerator. Refer to "Section 7.2 Replacement of adsorber".

The Compressor requires maintenance. Read "Section 7 Maintenance" thoroughly and conduct regular maintenance.

1.6 Compressor specifications

1.6.1 External view

Figure 1-2 shows external view of C30VR.



(Front)

(Rear)

Figure 1-2

C30VR External view

The model name is indicated on the front of the compressor as shown in Figures 1-3 and 1-4.

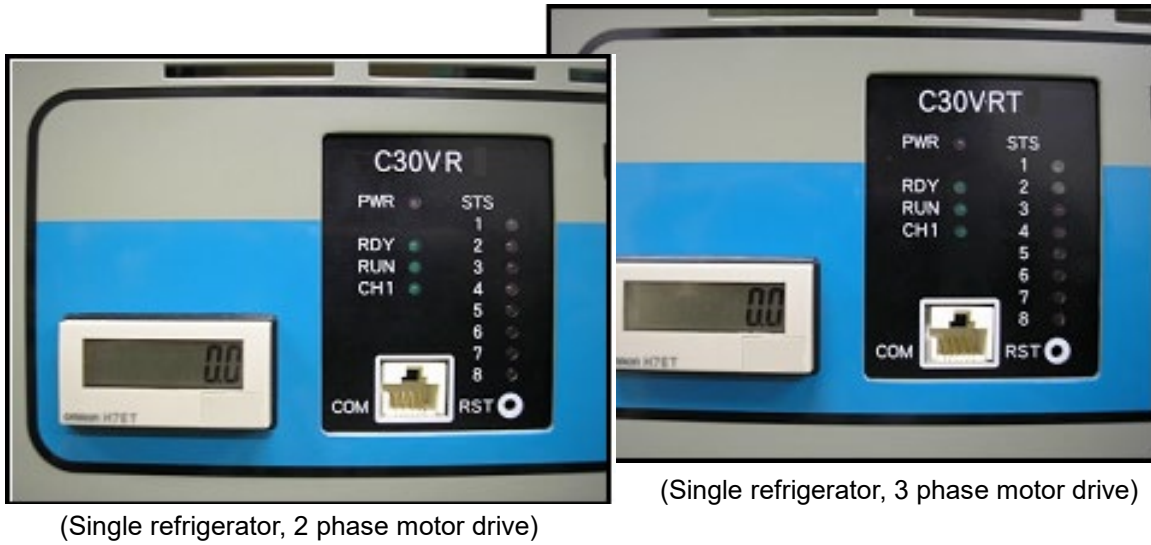


Figure 1-3 C30VR Front panel (Part)

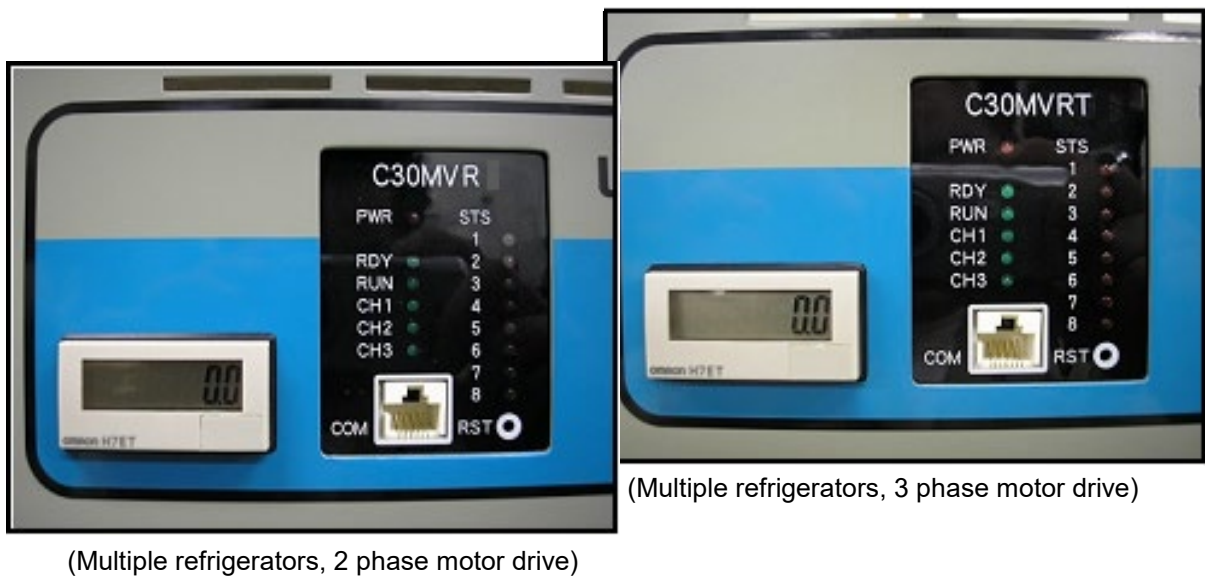


Figure 1-4 C30MVR Front panel (Part)



CAUTION

Do not place objects or equipments on top of a compressor. It prevents heat to be released from compressors as well as applying unnecessary heat to the equipments placed on it.

1.6.2 Dimensions

Figure 1-5 shows the dimensions.



Figure 1-5 C30VR Compressor dimensions

1.6.3 Weight

Table 1-2 shows weights of different types of compressor.

Table 1-2 Compressor weight

Model	Weight [kg]
C30MVR	131
C30VR	127
C30VRT, C30PVRT, C30MVRT	121

*The weights in this table are of standard compressors. The weight depends on the specifications of the customer's order.

1.6.4 General specifications

The tables below show power supply rating, cooling water requirements, installation environment, operation requirements and electromagnetic environment resistance characteristics. (Tables 1-3 ~1-6)

Table 1-3 Power supply rating

Item		C30VR C30MVR C30VRT C30MVRT	C30PVRT
Rated working voltage	50Hz	190 – 220 VAC	
	60Hz	200 – 230 VAC	
Power phase		3	
Stationary power Consumption	50Hz	5.0kW	5.7kW
	60Hz	6.0kW	7.5kW
Power factor		0.85	
Stationary electric current consumption ^(*)	50Hz	17A	19A
	60Hz	21A	24A
Locked rotor electric current		151A	
Customer-supplied rated electric current (minimum) ^(*)		30A / 5kA	40A / 5kA
Grounding		D class grounding (with the ground resistance of 100Ω or less)	
^(*) During cooling down of the cryopump, until it stabilizes at a low temperature, the electric current value is about 10% larger than the stationary electric current. Longer flexible hoses also increase the electric current. (A set of 20m flexible hose will increase the electric current by 5% compared to the nominal value. ^(*) Circuit Breaker Current Rating / Interrupt Rating			

Table 1-4 Cooling water requirements

Item	Requirements
Water temperature (Cooling water inlet)	5 – 32 °C
Flow rate	5 - 15 L/min
Cooling water supply pressure	Max. 0.7MPaG
Pressure drop (water inlet to water outlet)	0.02 – 0.17MPa (See Fig. 2-3)
Alkalinity (pH)	6.5 – 8.0 pH
Calcium Carbonate	< 75ppm
Refer to "Section 2.4 Cooling water requirements" for more details.	

Table 1-5 Installation environment and operation requirements

Item	Requirements		
	C30VR, C30MVR (For trap operation)	C30VR, C30MVR C30VRT, C30MVRT	C30PVRT
Ambient operating temperature	10 – 35 °C		
Ambient storage temperature	-10 – 55 °C		
Humidity	5 - 90% (non-condensing)		
Altitude	< 1000m		
Vibration	< 0.6G, 10 – 55 Hz		
Atmosphere	Free from metal powder, dust, flammable and corrosive gas		
Static helium pressure at 20 °C ^(*)	1.3±0.04MPaG	1.2±0.04MPaG	1.4±0.04MPaG
Sound pressure level during operation	< 70 dBA		
^(*) Refer to "Section 5.1 Verification of helium static pressure" for details.			

Table 1-6 Electromagnetic environment resistance characteristics

Item	Specification
Insulation resistance (Between power supply, Input-output and Ground)	5MΩ and more / 1 min. (500V megohmmeter)
Dielectric withstanding voltage (Between power line and ground)	1500V / 1 min.
Noise immunity (Power line) (*1)	±1500V
Noise immunity (Input-output line) (*1)	±500V
(*1)By fast transient/burst method. Test duration : 1 min.	

1.7 Component descriptions

This section describes components which need adjustments and/or verifications during operation and maintenance.

Compressor front view is shown in Figure 1-6 and rear view in Figure 1-7 (both C30MVR).

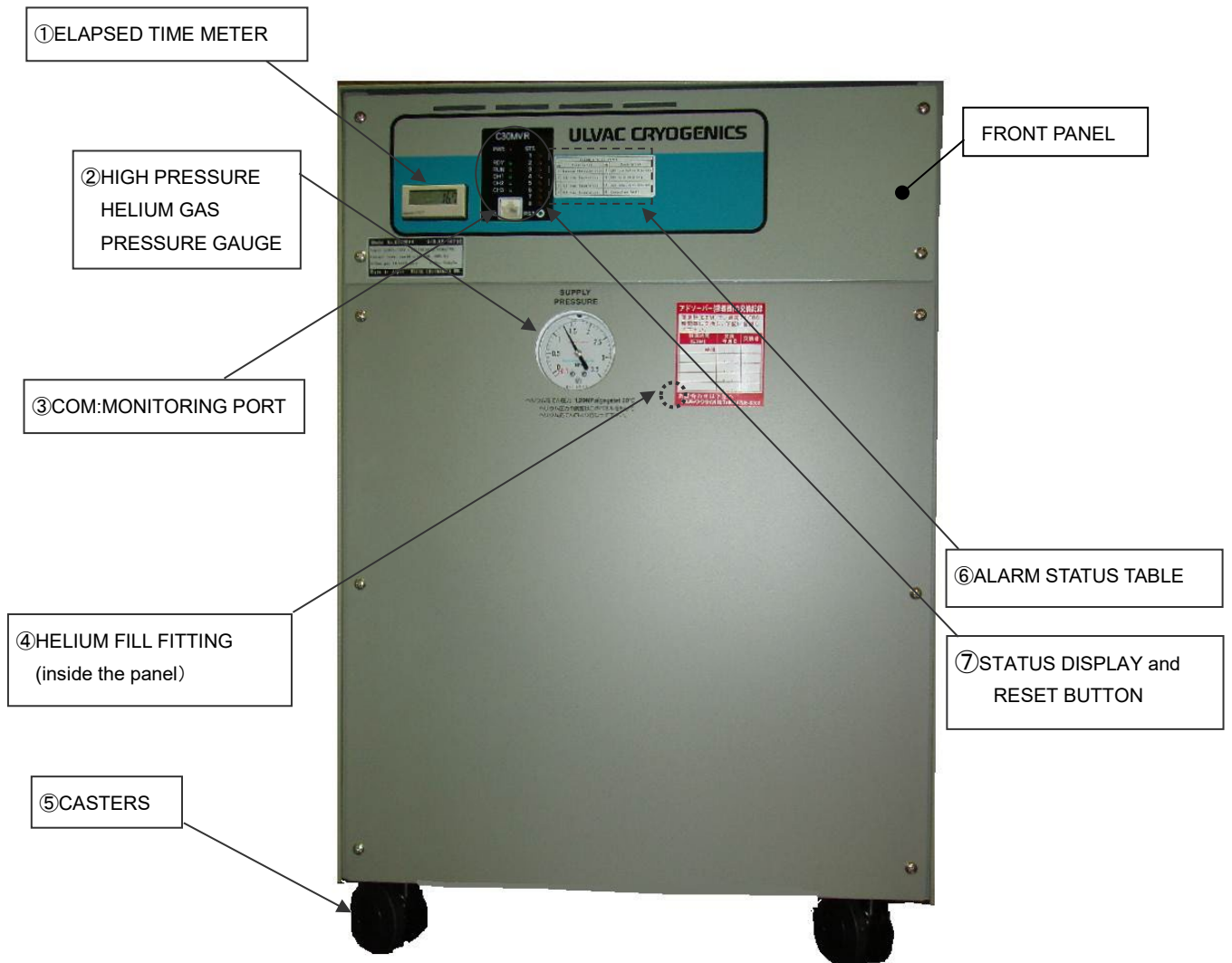


Figure 1-6 Compressor front view

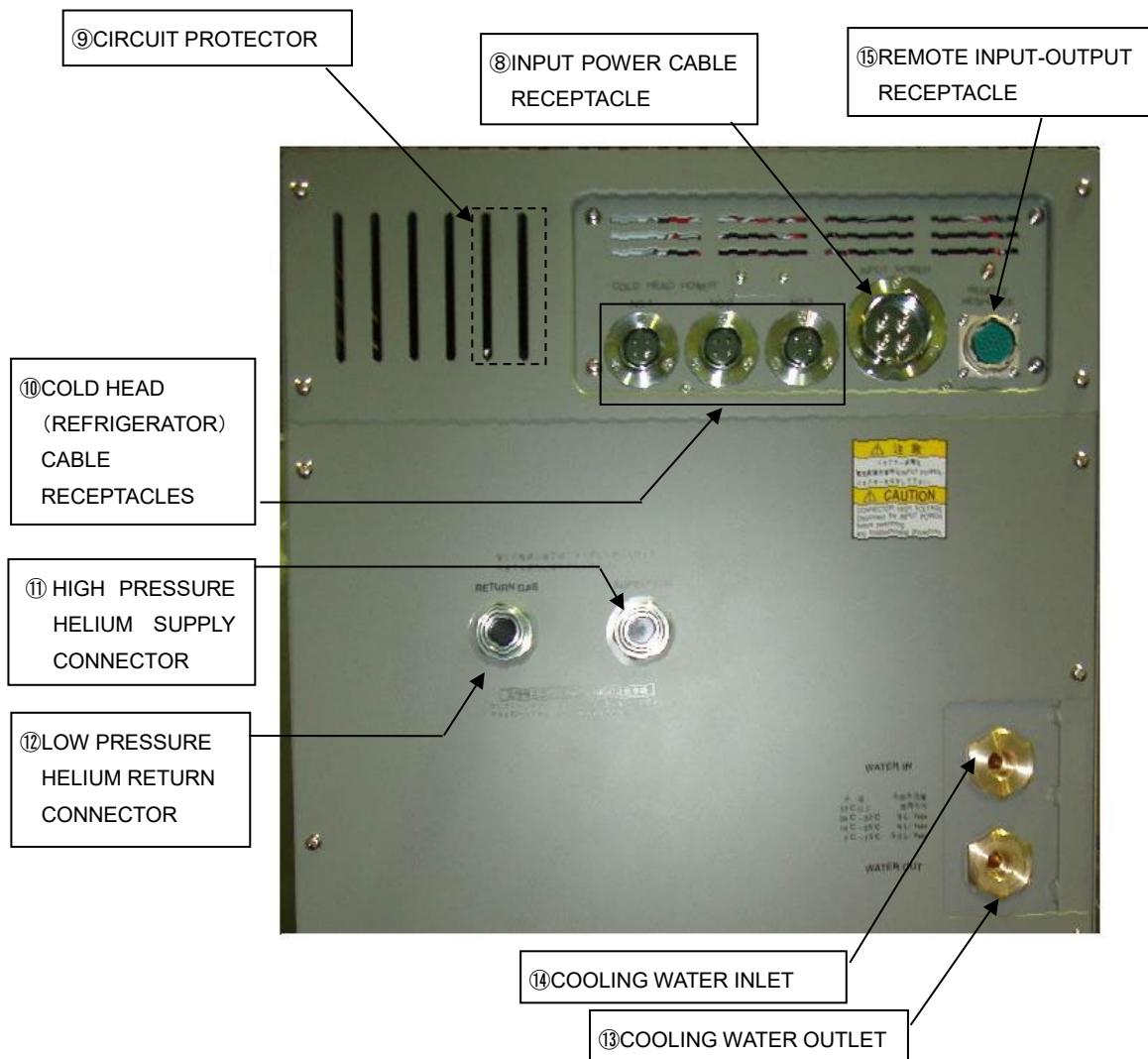


Figure 1-7 Compressor rear view

Listed below are the descriptions of components on the front panel of the compressor.

① ELAPSED TIME METER

It displays the elapsed time of operation (when it is in operation). The displayed value can not be changed.

② HIGH PRESSURE HELIUM GAS PRESSURE GAUGE (HELIUM PRESSURE GAUGE)

The high pressure helium gas pressure gauge, hereafter “the helium pressure gauge” indicates the static helium filling pressure when the compressor is not in operation, and the supply line helium pressure when the compressor is in operation. Refer to “Section 5.1 Verification of helium static pressure” to verify the helium pressure when the compressor is not in operation.

③ COM: MONITORING PORT

This is a port for inspection of our engineer exclusive use. Please note that you cannot access this port.

④ HELIUM FILL FITTING (Inside the panel)

Use this to adjust helium gas pressure when needed. When adding helium gas, use only helium gas with a purity of 99.999% or above.

Refer to "Section 7.3 Adjusting system helium pressure" for details.

⑤ CASTERS

Use them to move the compressor. Lock the casters when not moving the compressor.



CAUTION

All casters of the compressor unit must be locked after the compressor unit has been placed at a proper position or in storage. This is to avoid injury to persons from an unexpected slippage of the compressor.

It is also required to have preventative measures for slippage and/or overturning in case of earthquake. Please contact us if fixing brackets need to be attached to the compressor. Figure 1-8 shows an example of anchor bolts mounting positions when fixing brackets are attached to the compressor.

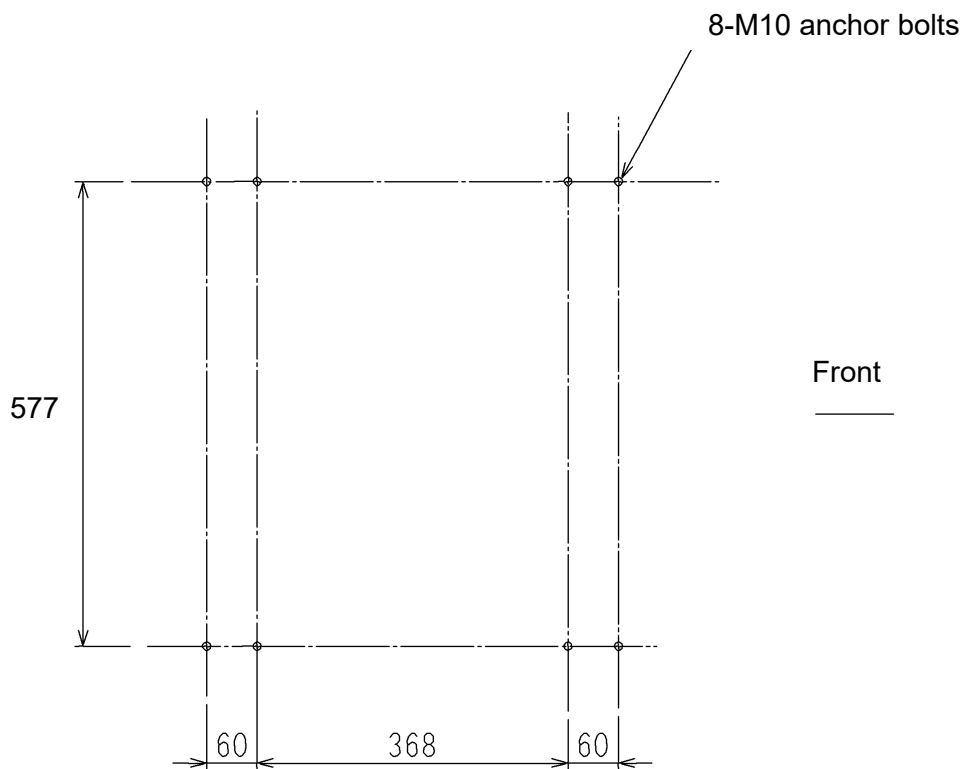


Figure 1-8 Anchor bolt locations (example)

⑥ALARM STATUS TABLE

This shows a list of alarm codes indicated by the STS (Status) LED indicators for alarm indication. Refer to “Section 8.3 Alarm code descriptions” for troubleshooting procedure of each alarm code.

All status display LED indicators will remain unlit when there is no problem.

⑦STATUS DISPLAY and RESET BUTTON

There are two kinds of status display, 4 or 6 LED indicators for the operation status of the compressor and 8 STS LED indicators for alarm indication. The number of LED indicators for the operation status is up to 6 depending on how many refrigerators are connected to the compressor (See Figure 1-3 and 1-4).

「PWR」 indicator (RED) lights up when the compressor is powered ON.

「RDY」 indicator (GREEN) lights up when the compressor is ready for operation.

「RUN」 indicator (GREEN) lights up when the compressor is in operation.

「CH1」 indicator (GREEN) lights up when refrigerator No.1 is in operation.

「CH2」 indicator (GREEN) lights up when refrigerator No.2 is in operation.

「CH3」 indicator (GREEN) lights up when refrigerator No.3 is in operation.

NOTE: “CH2” and “CH3” indicators are effective only for the C30MVR which can be connected to multiple refrigerators.

One or more STS LED indicators for alarm indication will light up when malfunction of the compressor is detected. Hereafter this event is referred to as alarm in this manual. When an alarm lights up, the buzzer will be activated as well.

In an event of alarm, check the status with the ALARM STATUS TABLE (⑥ in Figure 1-6). Refer to “section 8.3 Alarm code descriptions” for more details.

STS LED indicators and the buzzer will keep the alarm status even after the alarm event has been cleared.

To clear the alarm status and stop the buzzer, push the reset button through the “RST” hole with a thin rod.

Then, the “RDY” indicator will light up again.

Listed below are the descriptions of components on the rear panel of the compressor.

⑧INPUT POWER CABLE RECEPTACLE (INPUT POWER)

Connect the power cable plug to this receptacle.

Refer to “Section 4.6.1 connecting the input power cable” for how to connect the power cable.




CAUTION

The Compressor unit is supplied main power from the distribution panel of the customers' system. The distribution panel must have an appropriate circuit breaker for the compressor in accordance with the national and local codes and standards of the applicable country.

⑨CIRCUIT PROTECTOR (Inside the panel)

The circuit protector is installed in order to protect wiring and connectors from the over-current produced by an electrical overload or short circuit.

The circuit protector is set to ON when it is shipped.

		WARNING
<p>Circuit protector must be operated by authorized electrician familiar with the structure and the risk of this equipment. Failure to observe this warning may result in severe bodily injury or fatal accident.</p>		

⑩COLD HEAD(REFRIGERATOR)CABLE RECEPTACLES (COLD HEAD POWER NO.1, NO.2, NO.3)

Connect refrigerator cables for cryopump operation to these receptacles.

C30MVR has three receptacles (No.1~No.3).

C30VR has one receptacle (No.1).

⑪HIGH PRESSURE HELIUM SUPPLY CONNECTOR (SUPPLY GAS)

High pressure helium gas is supplied to the cryopump through this connector. A 1/2 self-sealing coupling is used.

Refer to "Section 1.5 Roles of compressor in cryopump system" to understand the operation of helium closed-loop cryopump system.

Also refer to "Section 4.3 connecting and disconnecting helium flexible hoses" for connection method of helium lines.

⑫LOW PRESSURE HELIUM RETURN CONNECTOR (RETURN GAS)

Connect a return line of low pressure helium gas from cryopump to this connector. A 1/2 self-sealing coupling is used.

Refer to "Section 1.5 Roles of compressor in cryopump system" to understand the operation of helium closed-loop cryopump system.

Also refer to "Section 4.3 connecting and disconnecting helium flexible hoses" for connection method of helium lines.

⑬COOLING WATER INLET (WATER IN)

Cooling water from customer's facility is supplied through this inlet to cool the compressor during operation. Customers need to have cooling water piping as a part of the facility.

Refer to "Section 4.2 Connecting cooling water piping" for connection of cooling water.

⑭COOLING WATER OUTLET (WATER OUT)

Cooling water used in the compressor returns from this outlet to customer's facility.

Refer to "Section 4.2 Connecting cooling water piping" for connection of cooling water.

⑮REMOTE INPUT-OUTPUT RECEPTACLE (REMOTE RESPONSE)

Connect the remote cables to this receptacle.

The cryopump and the compressor can be operated through the remote cables. It also enables sending of operation answer-back signals and alarm signals activated in an event of compressor failure to the equipment-side. Refer to "Section 2.6 Remote functions" for details of remote functions.

The plug for remote cables is supplied with the compressor. Customers need to solder the cables to use it. Refer to “Section 4.6.2 Connecting remote cables” for definitions of connector pin assignments and appropriate connection method for your application.

1.8 CRYO-U® cryopump multiple installation

C30MVR can operate up to three cryopumps at a time (See Table 1-1). Figure 1-9 depicts a typical multi-cryopump installation with single compressor.

For detailed instructions on cryopump installation with compressor, refer to “Section 4.4 Single cryopump installation” and “Section 4.5 Multiple cryopump installation”

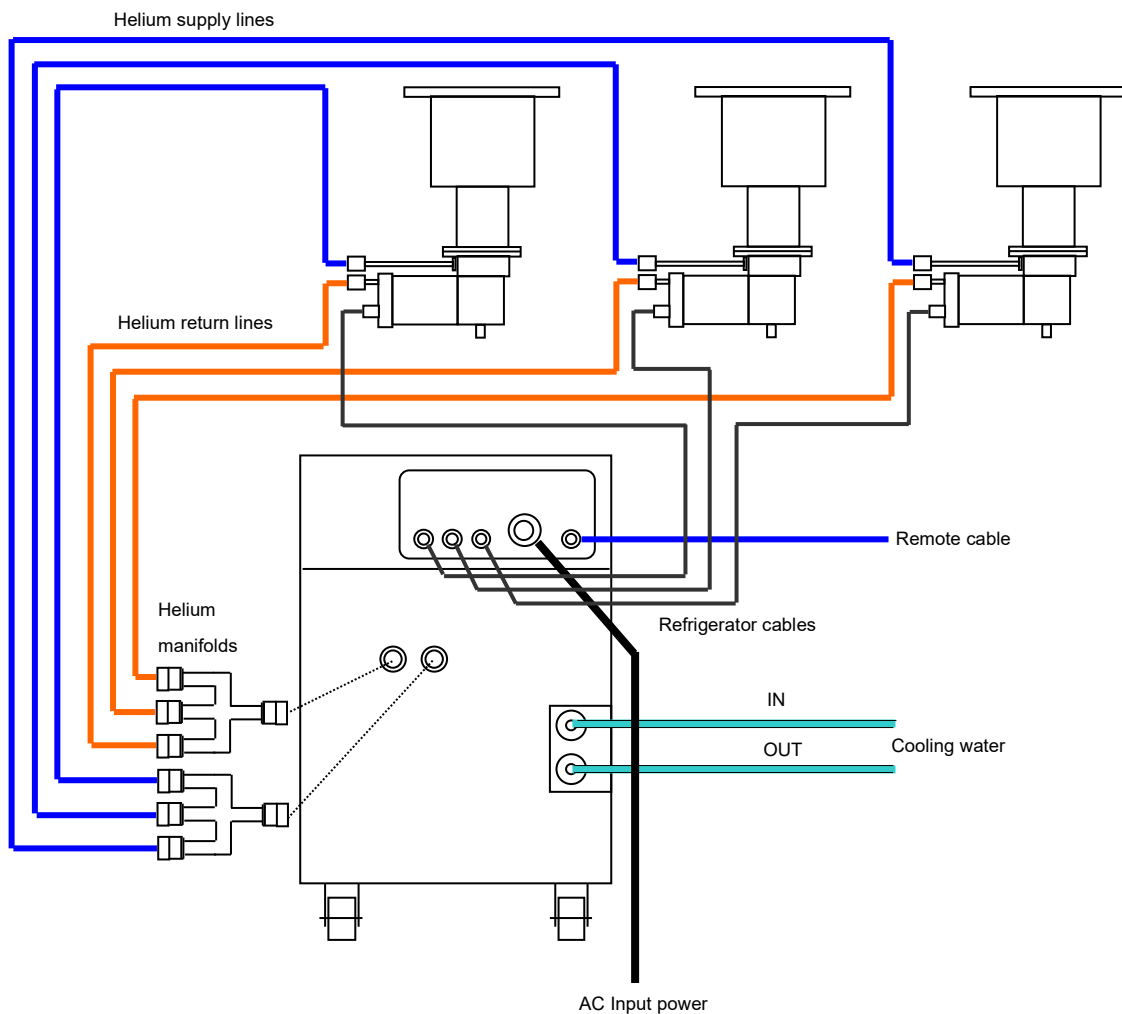


Figure 1-9 Cryopump installation with C30MVR compressor

1.9 Compressor with inverter for refrigerator

A small sized inverter for a cryopump refrigerator can be attached to a C30VR compressor to shorten cool down time and regeneration time by changing operation frequency. Figure 1-10 shows the appearance of the C30VR with an inverter.

Wire connections and the settings such as inverter frequency depend on your application and system. Please consult with our Service Engineering Division or contact to the nearest customer support center.

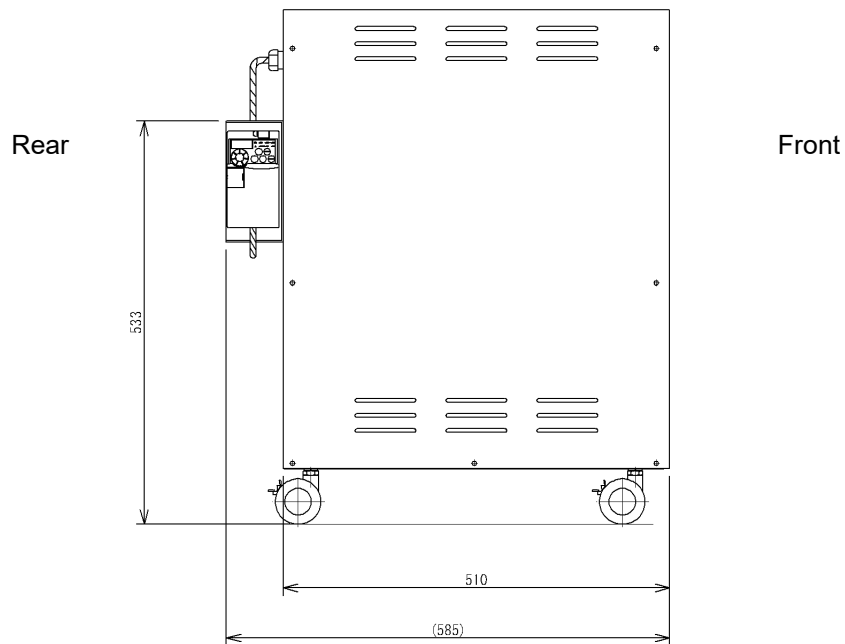


Figure 1-10 C30VR compressor with inverter

This page intentionally left blank.

Section 2 Considerations before Installation

2.1	Combination of cryopump and compressor	2-1
2.2	Installation environment requirements	2-1
2.3	Wiring requirements	2-2
2.4	Cooling water requirements	2-4
2.5	Length of cables and flexible hoses	2-7
2.6	Remote functions	2-7

This section provides the information which should be considered before installing the compressor. Below are the explanations of combination with cryopump, installation environment requirements, wiring requirements, cooling water requirements, length of cables and flexible hoses, remote functions, and subsidiary functions.

NOTE: C30VR compressor and refrigerators which can be connected to C30VR do not comply with EN standard (CE mark) and American standard (NEC and UL standard) by itself. Please consider our C30F2 or C30F4 cryopump system in order to comply with your local state, national, federal and international standards as a unit.

2.1 Combination of cryopump and compressor

Refer to the table in “Appendix B Combination of C30VR Compressor and Cryopump/Super trap” for typical combinations of cryopumps/super traps and compressor units.

2.2 Installation environment requirements

Refer to Table 1-5 in Section 1 and check the installation environment and operating conditions to ensure there is no problem. The environment should be free from contaminants such as oil, coolant and other suspended solids. Compressor should be installed in a space with enough ventilation to avoid suffocation in a case of helium leakage.

Figure 2-1 shows the dimensions of installation space and levelness of the floor required to maintain the performance of a compressor. The compressor should be installed on a flat floor surface.



CAUTION

Clear the back, front and sides of the compressor to maintain cooling by natural air flow. Also, a space of 500mm back and front of the compressor is needed for maintenance. Around the power cable in the back, keep space for working easily. In addition, easy access to the handle of main circuit protector (MCP) on the back must be ensured.

Refer to Figure 1-5 in Section 1 for the dimensions of the compressor.

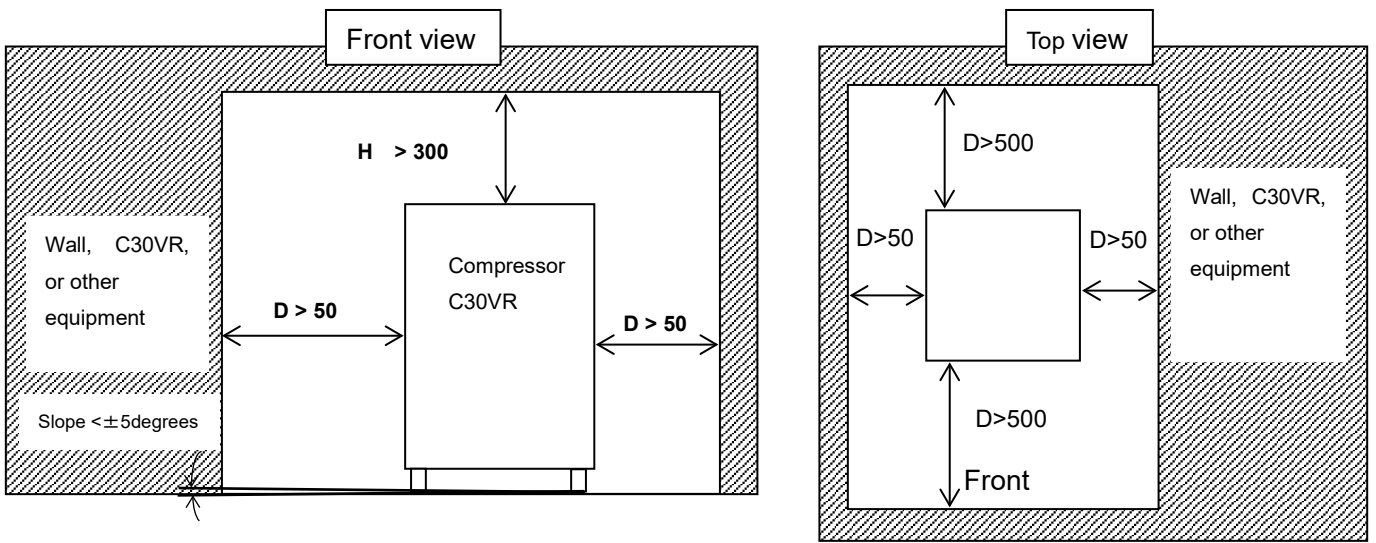


Figure 2-1 Required space for compressor installation (scale: mm) and levelness


2.3 Wiring requirements

Table 2-1 shows the specifications of optional input power cables. For connecting procedures of the input power cable refer to “Section 4.6 Electrical connections”.

Table 2-1 Input power cable specifications

Item	Symbol	C30VR, C30VRT C30MVR C30MVRT	C30PVRT
Input power cable	INPUT POWER	Copper wire / 600VAC, 3 conductors with ground ^(*)	
		5.5mm ²	5.5mm ² , 8 mm ² ^(*)
^(*) The color of the ground wire is green.			
^(*) Unless otherwise specified, 5.5 mm ² cables are attached to the compressor.			

Supply AC power for compressor from the equipment-side distribution panel. The distribution panel should have branched circuit breakers for each compressor (see Figure 2-2). Circuit breakers must be appropriate and meet the international and the national codes and standards of the country installed (Refer to UL489 and IEC60947-2). Also, circuit breakers must be installed in the distance to be able to check the compressor. Refer to Table 1-3 in section 1 for circuit breaker current rating.



CAUTION

In most standards, it is required to install a branch breaker to protect power cables connected to the equipments. A circuit breaker must be installed. Failure to follow this procedure could seriously damage the equipment.

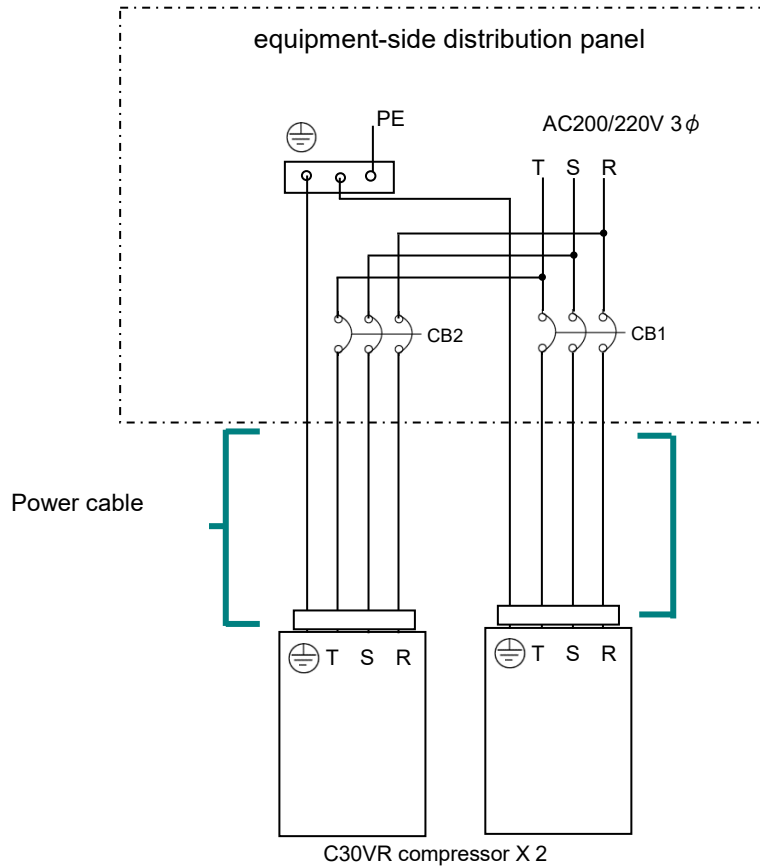


Figure 2-2 Equipment-side power circuit

Table 2-2 shows wire gauges of refrigerator cable and remote cable for use.

Table 2-2 Control and signal wire gauges

No.	Item	Symbol	Connection Type	Wire Size	Note
1	Refrigerator cable ^(*)	NO.1, NO.2, NO.3	Connector	#20 AWG	Option
2	Remote cable	REMOTE RESPONSE	Connector	#22 AWG	Customer supply

^(*) It is a specialized cable compatible with conventional general-purpose compressors such as C30V and C30MV. Current rating of the refrigerator is less than 0.7A.

ATTENTION: Refer to “Section 4 Equipment Installation, Piping, and Wiring” for routing of the cables above.

2.4 Cooling water requirements

Cooling water must meet the requirements indicated in the following subsections. It is necessary to maintain the performance of the compressor for extended periods without malfunction.

2.4.1 Checking chemicals and quality of water

Table 2-3 indicates recommended quality of water. Ensure that cooling water meets the requirements in the table. If the quality of water is not in allowable ranges, water quality improvement may be needed.

Table 2-3 Recommended cooling water for compressor

Item	Unit	Allowable Range
pH (25°C) (*1)	pH	6.5 - 8.0
Conductivity (25°C) (*1)	mS/m	< 30
Chloride ion, Cl ⁻ (*1)	mg / L	< 50
Sulfate ion, SO ₄ ²⁻ (*1)	mg SO ₄ ²⁻ / L	< 50
Acid consumption (pH4.8) (*1)	mgCaCO ₃ / L	< 50
Total hardness (*1)	mgCaCO ₃ / L	< 50
Total carbonic acid (*1)	mg / L	< 10
Calcium carbonate	mg / L	< 75
*1 The values of the items are based on the water quality management standards of Japan Refrigeration and Air Conditioning Industry Association.		

Note1: Table 2-3 is based on the water quality management standards of Japan Refrigeration and Air Conditioning Industry Association. Refer to local standards of water quality management where the compressor is installed outside Japan. It is necessary to check chemicals and water quality to avoid corrosion, clogging, and other faults caused by low quality of water and/or chemicals.

Note2: Ground water may contain a great quantity of carbonate acid which facilitates corrosion. Ensure to perform carbonate check as soon as water is taken from ground without exposing water to atmosphere. Otherwise the result may be false.

Note3: Use tap water, industrial water or groundwater as cooling water. Do not use pure water, gray water nor softened water.

2.4.2 Determining pressure, temperature and flow rate of cooling water

Refer to Table 1-4 in Section 1 for typical cooling water requirements.

The pressure of cooling water for supply lines must be 0.7MPaG or less.

Figures 2-3A and 2-3B show the relation of water flow rate, water temperature, and water pressure loss (See Figure 2-4 for C30PVRT and see Figure 2-3 for other models). Use these graphs in Figure 2-3 or 2-4 to determine the flow rate of cooling water.

For example, from the graphs in Figure 2-3 the allowable range of the flow rate for C30MVR is from 7 to 15L/min at water temperature of 30°C. Also you can see the water pressure drop between the cooling water inlet and outlet is 0.04MPa at a flow rate of 7L/min.

Determine the values for water flow rate and pressure loss so that the compressor can be run with an enough margin to the water temperature change throughout the year.



CAUTION

If the cooling water temperature is lower than 10°C, stop the water flow when the compressor is suspended. If the cooling water of below 10°C is kept flowing, it may raise viscosity of lubricant oil and the compressor may fail to startup when turned on.

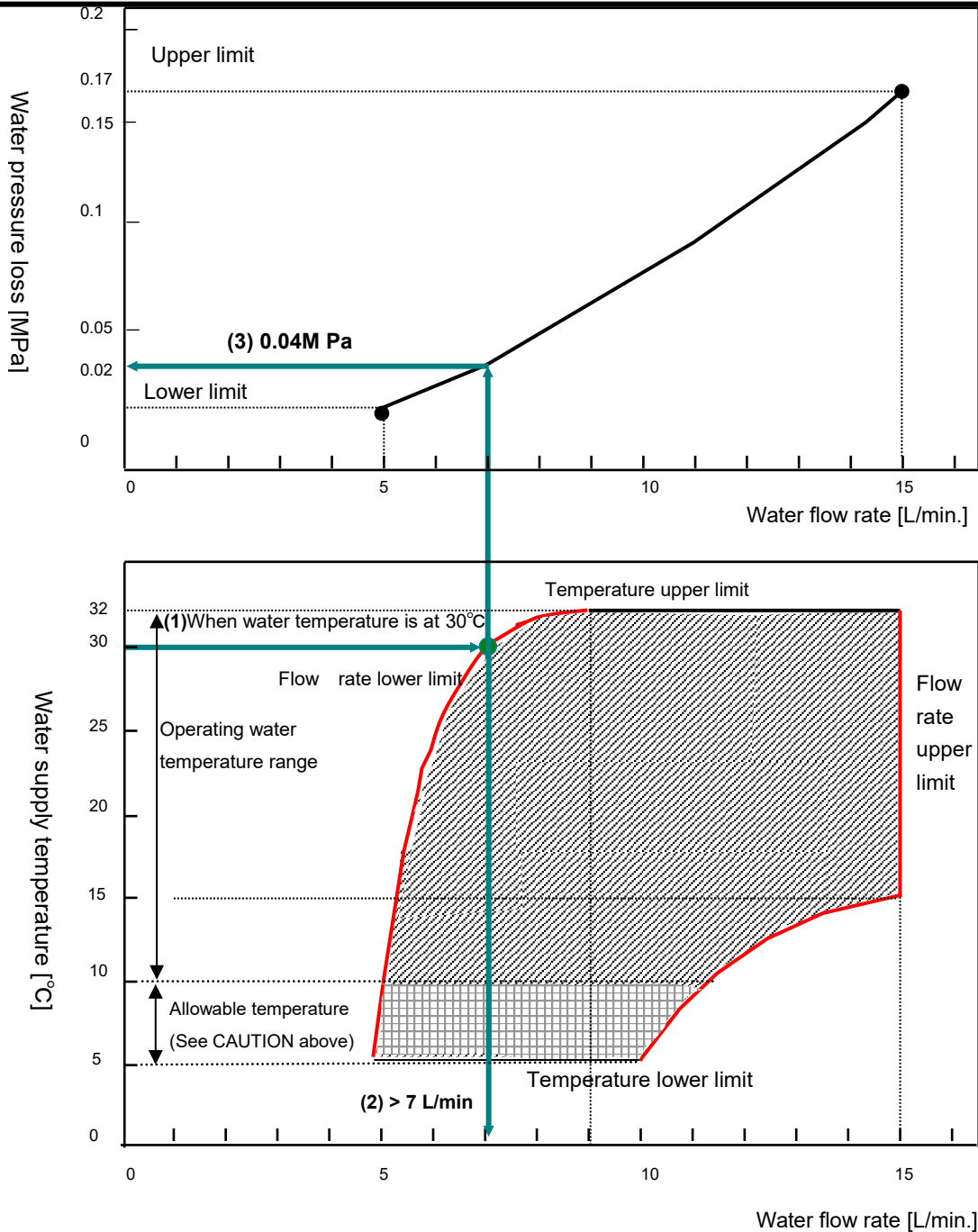


Figure 2-3 Cooling water flow rate, water supply temperature, and water pressure loss (Except for C30PVRT)

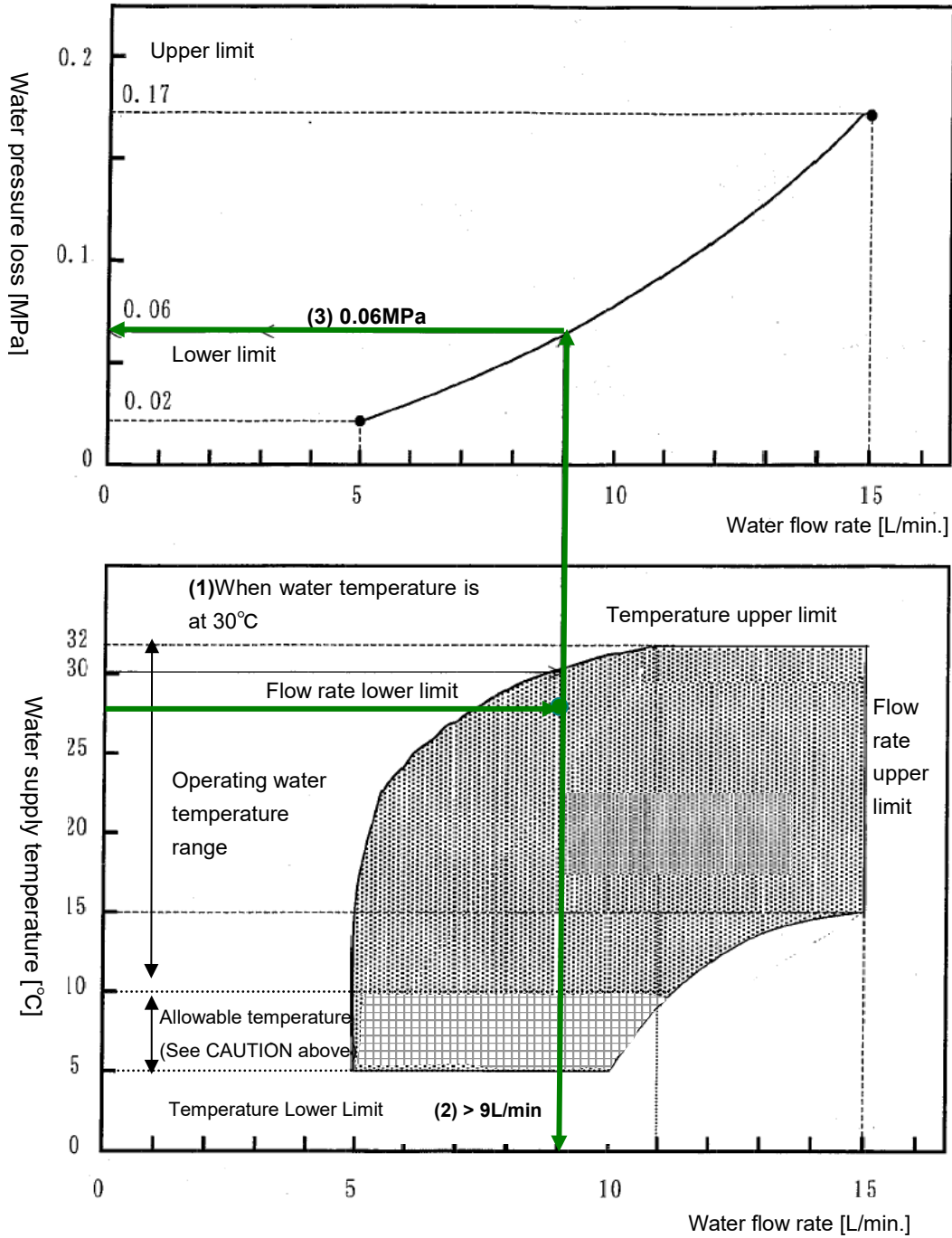


Figure 2-4 Cooling water flow rate, water supply temperature, and water pressure loss (For C30PVRT)

2.4.3 Directions for using cooling water

Rc 3/8 female pipe thread is used for both “Cooling water inlet” and “Cooling water outlet”.

It is recommended to install a filter in the “Cooling water inlet” line in order to remove contaminant in the cooling water. Also, installing a water flow meter in the cooling water line of the compressor is recommended.

It is recommended to have an air blower in your facility to drain the compressor. To use an air blower, connect the hose for the air blower to the “Cooling water inlet” fitting instead of the cooling water pipe which is used usually.

2.5 Length of cables and flexible hoses

Standard length of optional cables and flexible hoses are listed in Table2-4.

Table 2-4 Standard cables and flexible hoses

Item	Standard length [m]	Quantity
Input power cable	3	1
Refrigerator cable	3	*
Flexible hose	3	2 x *
*** shows total number of refrigerators connected to single compressor.		

NOTE: Please contact our Service Engineering Division or the nearest customer support center for different length of cables and/or flexible hoses.

2.6 Remote functions

Compressors can be remote-controlled from customer’s equipment side.

The following provides information on features and functions of the remote interface and the time chart of signals. It is also available to select an operating mode of the compressor in accordance with your applications. The following information also contains instructions for selecting operating modes.

2.6.1 Remote Interface Specifications

Remote Interface Specifications are indicated in Table 2-5.

Table 2-5 Remote interface specifications

Item			Specification
Model	Signal	Quantity	
C30VR	Input	3	Photo Coupler Isolation Input Maximum Input voltage: 26VDC, Input Current: less than 8mA Rated Input Voltage: ON:20V and above, OFF:3V or less
C30MVR		6	
C30VR	Output	2	No-voltage a contact Maximum Load: 30VDC / 100mA
C30MVR		5	

2.6.2 Remote input interface circuit

Figure 2-5 shows the remote input interface circuit.

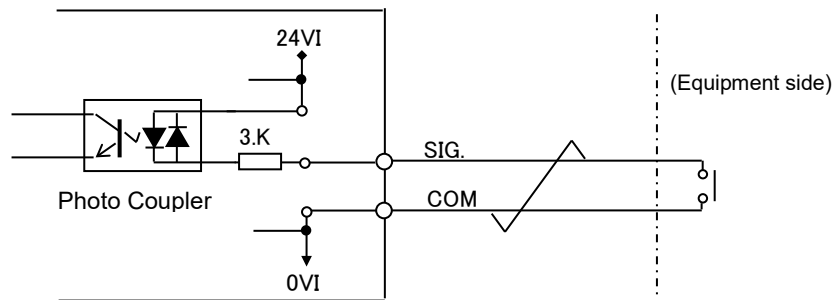


Figure 2-5 Remote input interface circuit

Note that the 0VI is not connected to the ground line inside the compressor in the input circuit. COM line is common with all other inputs.

2.6.3 Remote output interface circuit

Figure 2-6 shows the remote output interface circuit.

Each output is an isolated output contact. At the equipment side different power supply can be used for each signal. However, considering that the wiring is sequence signal line, it is recommended to use a DC24V power supply for all signals.

Since it is the contact output, the polarity of DC24V in Figure 2-6 can be reversed. Make provisions for the interface circuit at the equipment side.

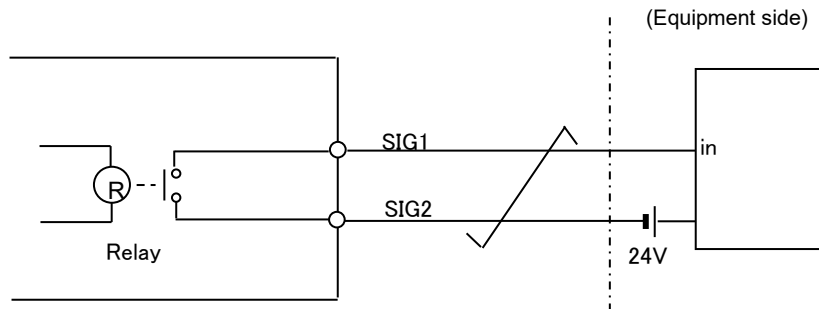


Figure 2-6 Remote output interface circuit

2.6.4 Signal names

Table 2-6 Remote interface signals

Type	S	M	Signal description	Signal name	
Input	Y	Y	Compressor start (Momentary operating mode)	COMP START	COM
	Y	Y	Compressor stop (Momentary operating mode)	COMP STOP	COM
	Y	Y	Compressor start/stop (Alternate operating mode)	COMP ON/OFF	COM
		Y	Refrigerator No.1 start/stop	CH1 REF	COM
		Y	Refrigerator No.2 start/stop	CH2 REF	
		Y	Refrigerator No.3 start/stop	CH3 REF	
Output	Y	Y	Compressor answer-back	COMP RUN1	COMP RUN2
	Y	Y	Alarm	ALARM1	ALARM2
		Y	Refrigerator No.1 answer-back	CH1 ACK1	CH1 ACK2
		Y	Refrigerator No.2 answer-back	CH2 ACK1	CH2 ACK2
		Y	Refrigerator No.3 answer-back	CH3 ACK1	CH3 ACK2
	Note: "S" stands for C30VR as single cryopump operation and "M" stands for C30MVR as multiple cryopump operation. "Y" indicates available signals for the models. Refer to "Section 4.6 Electrical connections" for details of signal names.				

2.6.5 Signal functions

The compressor can be controlled in two different operating modes, Momentary operating mode and Alternate operating mode. You can neither use both operating modes at the same time, nor switch one operating mode to the other depending on the situations. Ensure to choose one of the operating modes and connect signal lines needed for the operating mode you chose. Do not connect signal lines for the operating mode that you will not use. Decide the operating mode depending on the application of the equipment side. Momentary operating mode is equivalent to operate by using pushing button switch, and Alternate operating mode is equivalent to operate by using selector switch. Alternate operating mode is easier and simpler for use in general.

Selecting operating mode

1. Momentary operating mode
2. Alternate operating mode

Default operating mode is either Momentary operating mode or Alternate operating mode. The operating mode is switched automatically. The operating mode is determined by recognizing into which input pin the operation command of the compressor has entered after turning on the power supply.

Once the operating mode is selected, the mode will be kept until the compressor is turned off.

Signal functions only for Momentary operating mode**COMP START (Compressor start)**

The compressor pump starts operation by turning this command signal ON for a short period of time and the compressor keeps the operation status. Turn the command signal ON for more than 0.3 second. (Refer to the description of **COMP STOP** below).

For C30VR, when the compressor pump starts operation, the refrigerator starts at the same time.

For C30MVR, command signals for refrigerators (CH1 REF, CH2 REF, CH3 REF) should be turned ON to start the refrigerators.

COMP STOP (Compressor stop)

This is a paired signal with **COMP START**.

Use this signal to stop the compressor pump and refrigerator. Turn the command signal OFF for longer than 0.3 seconds and the compressor pump and all refrigerators will stop and keep the status.

Keep the signal ON unless you need to stop operation. To stop operation by this signal, **COMP START** signal must be turned OFF beforehand. However leave this signal ON when to turn ON **COMP START** signal.

Signal functions only for Alternate operating mode**COMP ON/OFF (Compressor start/Stop)**

With Alternate operating mode, turning this signal ON starts operation of the compressor pump and OFF stops all the refrigerators and the compressor.

With C30VR, when the compressor pump starts operation, the refrigerator starts operation at the same time.

With C30MVR, the command for refrigerators (CH1REF,CH2REF,and CH3REF) should be turned ON as well as this signal.

Signal functions for both operating modes**CH1 REF, CH2 REF, CH3 REF (Refrigerators No.1-3 start/stop)**

These signals are required for C30MVR only.

Use the command signals CH1REF~CH3REF at the equipment side depending on how many refrigerators are used. While the compressor pump is in operation, to start the refrigerator(s) turn ON the corresponding signal (either CH1REF, CH2REF, CH3REF, or all) . Turn OFF the signals and the refrigerator stops operation.

When the compressor pump is not in operation, it will not return the answer back signal (**CH* ACK**) even if this signal (**CH* REF**) is turned ON.

Note: For the operation after a short power interruption, refer to "Section 2.6.6 Signal timing charts – Operation after a short power interruption".

**CAUTION**

Do not switch between ON and OFF frequently. Switching between ON and OFF should be less than 6 times per hour, and each status should be maintained for longer than 3 minutes. Frequent startup and shutdown may shorten insulation life of coldhead motor, resulting in system failure.

When the refrigerator needs to be turned On and Off for controlling the temperature of our Super Trap, use our temperature controller.

COM

Each input "COM" line works as a return line of a corresponding control signal. It is recommended to twist the signal line and the "COM" line together.

Also, output signal wires mentioned below should be twisted as a paired signal. (e.g., CH1 ACK1 - CH1 ACK2)

COMP RUN (Compressor answer-back)

This is an answer-back signal responding to the compressor pump operation command. When the compressor starts operation, the answer-back signal is sent to the equipment.

Note: Refer to "Section 2.6.6 Signal timing charts –Answer-back signal delay" as well.

ALARM (Alarm)

When this signal is OFF, the compressor is ready for operation, or in operation. When failure or malfunction occurs to the compressor, the signal turns ON, in other words, the contact output closes and the signal is conducted. To reset the alarm, push the "RST" button on the front panel of the compressor. However, the failure or malfunction should be cleared before the manual reset.

Note: When the compressor is turned OFF, ALARM signal turns ON for about two seconds.

It also turns ON for about 0.5 seconds at the start of applying current.

CH1 ACK, CH2 ACK, CH3 ACK (Refrigerators No.1-3 answer-back)

These signals are required for C30MVR only.

They are Answer-back output signals responding to each refrigerator command (CH* REF).

When the refrigerators start operation, these answer-back signals will be sent to the equipment.

2.6.6 Signal timing charts

Figure 2-7 shows a timing chart for “Alternate operating mode” with two refrigerators.
Figure 2-8 shows a timing chart for “Momentary operating mode” with two refrigerators.

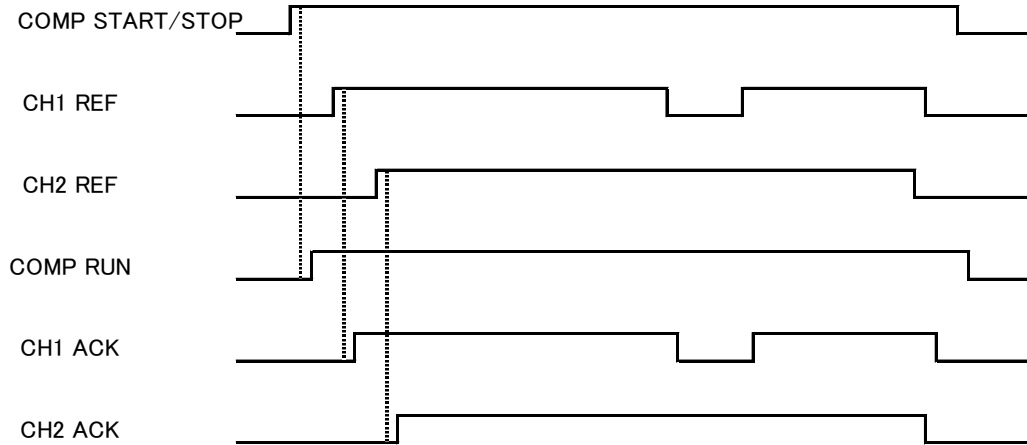
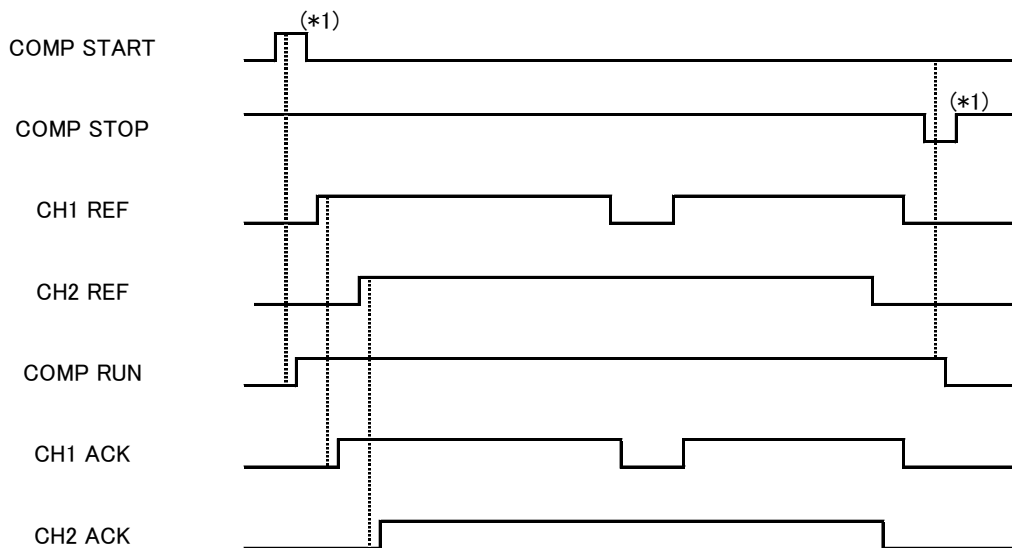


Figure 2-7 Timing chart for Alternate operating mode with two refrigerators



*1) The holding time is 0.3 seconds or more.

Figure 2-8 Timing chart for Momentary operating mode with two refrigerators

(Delay and recovery of Answer-back signal)

Please be sure to set the timeout time of an answerback signal as 8 seconds or more. The reason is explained below.

In normal operation, an answer-back signal is fundamentally send to the equipment side within a maximum of 0.3 seconds delay in response to a command signal. In the following conditions, however, the answer-back signal is sent behind time:

- (a) When the power supply of the compressor is turned ON
- (b) When the reboot command of the compressor is emitted within 0.3 second from

- the operation stop command
- (c) When a short power interruption for less than 2 seconds has occurred

In case of the above (a), it takes a few seconds for the compressor to initialize after it is powered on. Therefore the compressor will neither recognize nor output any remote signal with the equipment for a maximum of 5 seconds. For reference, the signal delay when powered on in Alternate operating mode is shown in Figure 2-9.

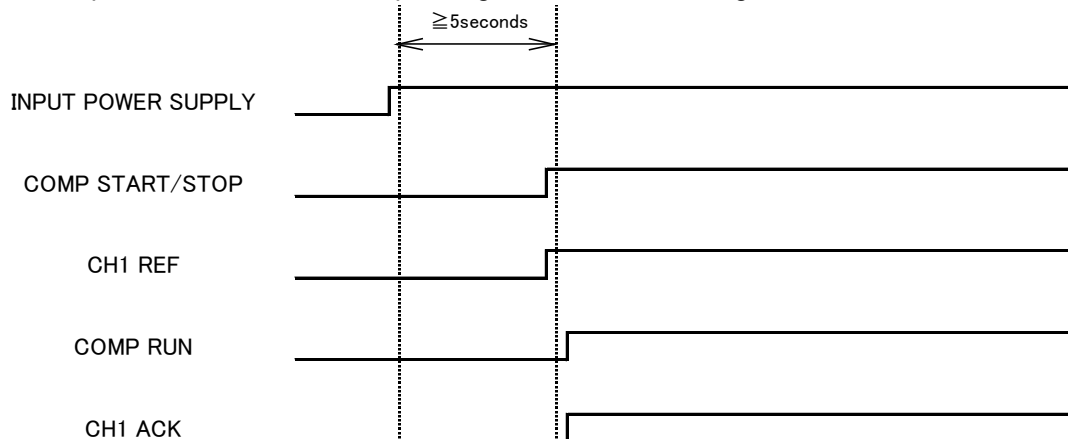


Figure 2-9 Signal delay when powered on (In Alternate operating mode)

In the cases of (b) and (c), the answer-back signal is also delayed for a maximum of 5 seconds to respond to the command of "COMP RUN". This is because the compressor pump waits to begin its operation until the helium pressure inside becomes stable. For references, Figure 2-10 shows the signal delay occurred in Alternate operating mode when the time period from a stop to a reboot is short, and Figure 2-11 shows the timing chart of C30VR when a short power interruption has occurred in Momentary operating mode.

From the above-mentioned, the set value of the timeout of the answer-back signal should be determined based on the condition in which only the compressor has detected a short power interruption although a user's equipment is not detecting it because of differences of the specifications. In this condition, the equipment must recognize that the compressor is out of order because the equipment side can't receive the answer-back signal. If dispatch of the answer-back signal will be late for a preset timeout time even if the compressor has restarted after recovery of the input power, an alarm of a stop will come out.

Therefore, be sure to set the timeout time of an answer-back signal as 8 seconds or more in order to monitor the operating conditions of the compressor correctly.

Note: Figure 2-11 leads the following equation:

$$td + tw + 1 \leq 2 + 5 + 1 = 8 \text{ (seconds)}$$

Where, "1" second is a margin added.

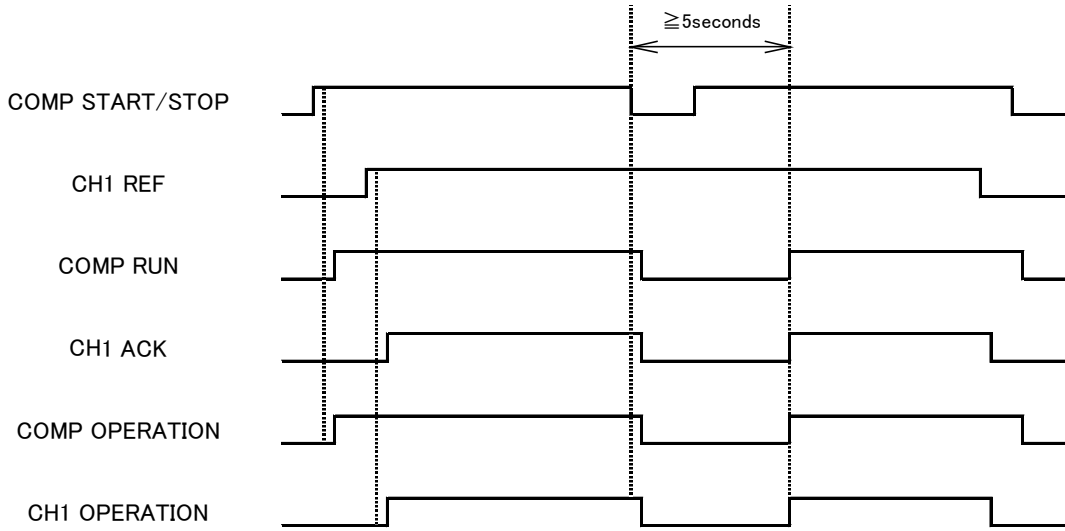


Figure 2-10 Signal delay when the time period from a stop to a restart is short
(In Alternate operating mode)

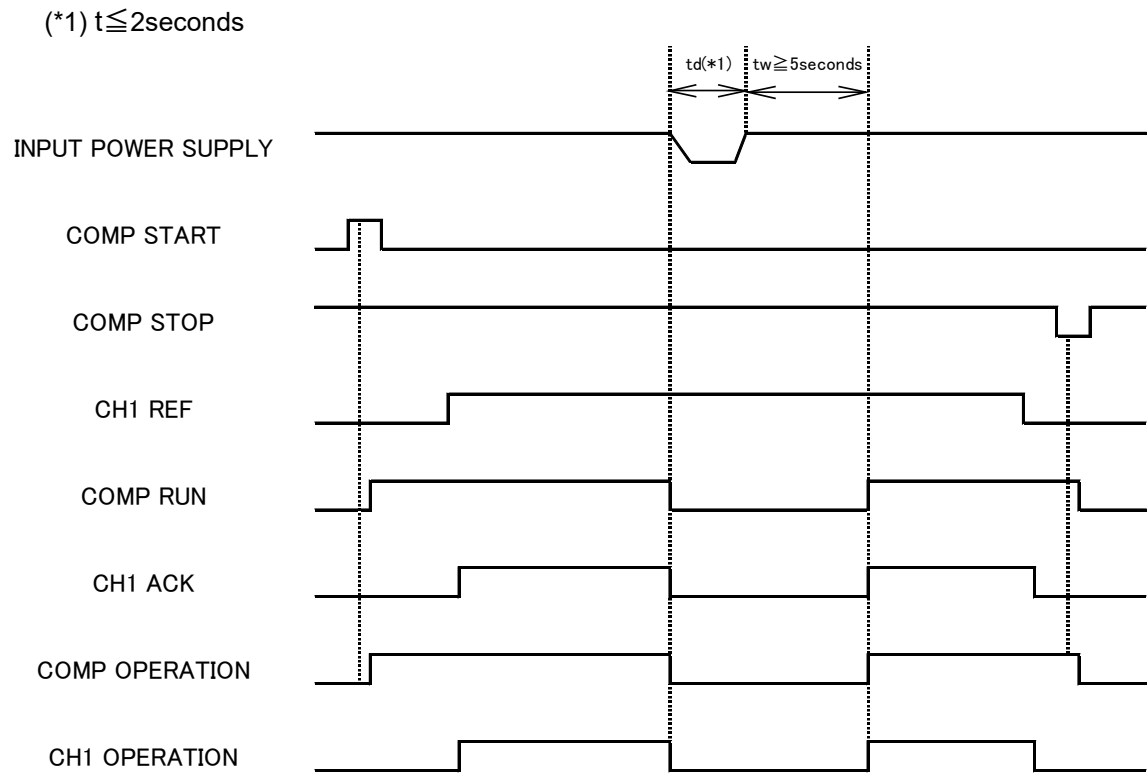


Figure 2-11 Timing chart of C30VR when a short power interruption occurs
(In Momentary operating mode)

(Operation after a short power interruption)

While the compressor is running in “Momentary operating mode”, if a short power interruption occurs and the input power is recovered within two seconds, the compressor pump restarts the operation automatically.

For C30VR, refrigerator operation is synchronized with the compressor operation as shown in Figure 2-11. On the other hand, for C30MVR, refrigerators operation depends on the command from the equipment side after the input power is recovered.

In “Alternate operating mode”, the compressor restarts as soon as the input power is recovered because there is always the command from the equipment side.

NOTE: Refer to “Section 4.6.2 Connecting remote cables” for remote signal wiring.

This page intentionally left blank.

Section 3 Unpacking and Inspection

3.1	Compressor carton	3-1
3.2	Shipping carton inspection	3-1
3.3	Unpacking	3-2
3.4	Carton contents	3-3
3.5	Inspection of the compressor and accessories	3-4
3.6	Flexible hoses and specifications	3-4

3.1 Compressor carton

Compressors are shipped in a carton with wooden frame at the bottom.



CAUTION

Do not throw, jolt, push down on or tip over the cartons. It may result in damaging the equipment.

3.2 Shipping carton inspection

Inspect the carton before unpacking for evidence of damage such as dents, breakage, wetness and/or signs that the carton has been tipped over. If there is any damage please contact the delivery company immediately.



Figure 3-1 Appearance of compressor carton

3.3 Unpacking

Use handling equipment such as a forklift for carrying the compressor.



CAUTION

Compressor weighs 121 - 131kg. Use handling equipment such as a forklift to move or lift the compressor. Only authorized personnel familiar with handling and risks of the equipment can operate the handling equipment. Personnel except for the operator of the handling equipment must keep away from the handling equipment and the compressor during the handling. There are risks of dropping and/or tipping over of the compressor. Failure to observe this warning may result in severe bodily injury or fatal accident.

Forklift is needed to remove the compressor from its shipping carton.
The procedure is shown below.

1. Cut the two straps of the carton.



CAUTION

When cutting the straps, handle a cutter with care and be aware of the flailing movement of the cut straps. Failure to observe this warning may result in severe bodily injury.

2. Lift the cardboard straight up and remove it from the bottom plate.
3. Insert the forks of the forklift between the bottom of the compressor and the bottom plate from the side of the compressor. (See Figure 3-2)
4. Ensure that the forks are inserted far enough to protrude from the other side and are well balanced.
5. Lift the compressor smoothly and move to a flat floor surface and bring down the compressor without shaking and/or jolting. After putting down the compressor on the floor, move it to the installation site by hand using the casters provided.



CAUTION

Bring down and place the compressor on the flat floor to avoid the compressor slipping. If the floor is sloped the compressor may move this could result in severe bodily injury or fatal accident.



CAUTION

After the compressor has been placed at an installation site, ensure to lock all casters of the compressor to prevent bodily injury by from unexpected movement or slipping of the compressor. Take adequate measures to prevent overturning of the compressor from earthquakes as needed. If it is required to mount clamps or brackets on the compressor, please contact our Service Engineering Division. Refer to section 1 Figure 1-8 for an example of anchor bolt mounting position when fixing brackets are mounted on the compressor.

It is highly recommended to keep the package cardboard box, wooden bottom plate, and other packaging materials. The packages can be used for storage and transport of the compressor or for returning it to us for servicing.

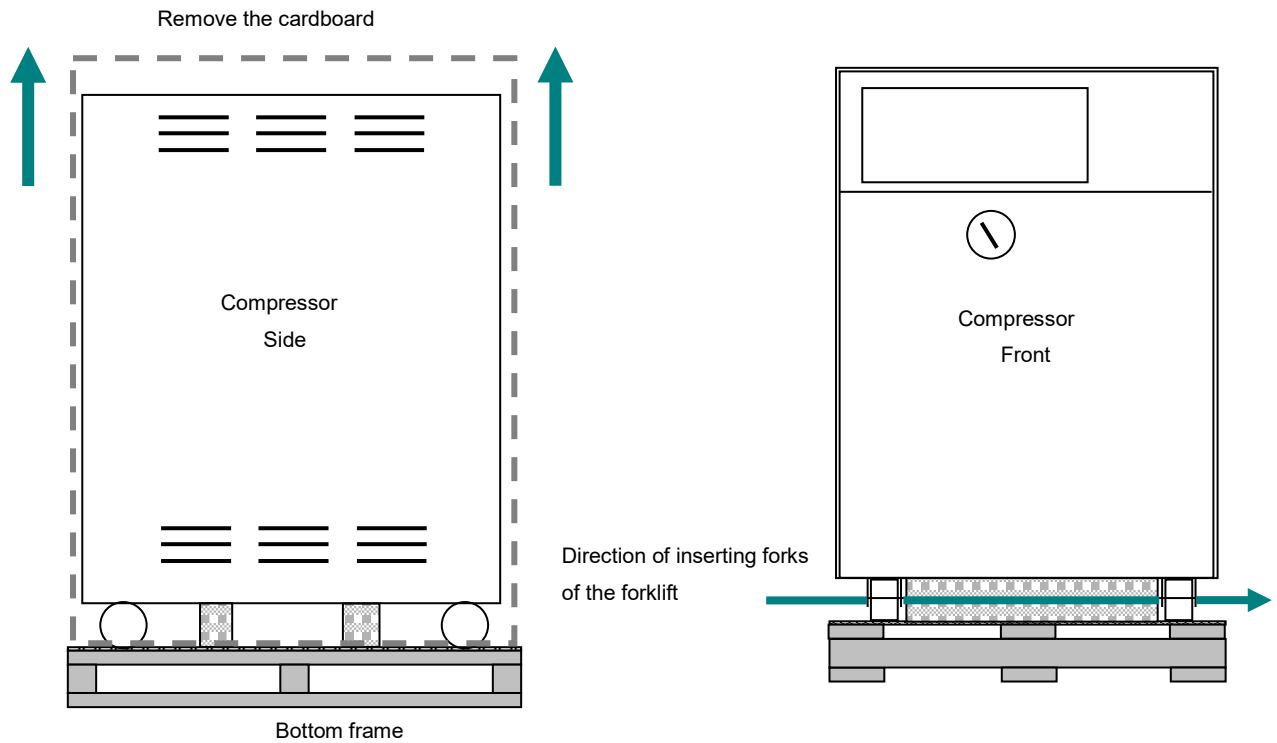


Figure 3-2 Remove cardboard and insert forks underneath the compressor

3.4 Carton contents

Table 3-1 is the lists of shipping carton contents. Please read the enclosed cover letter for the details. Depending on your specification, the option part(s) in Table 3-2 is attached.

Table 3-1 Carton contents

Item	Quantity
Compressor	1
Manual	1
Connector for remote operation	1

Table 3-2 Optional parts

Item	Quantity
Input power cable (3m or customized length)	1
Refrigerator cable(3m or customized length)	1 – 3 ^(*)
Flexible hose (3m or customized length)	2 – 6 ^(*)
Helium manifold (for multiple refrigerator operation)	2 ^(**)
Lipped bowl spanner (flexible hoses installing tool)	2
Gasket for helium coupling (spare)	4

^(*) The quantity depends on the number of refrigerators. For example, two refrigerators cables and four flexible hoses will be needed for two refrigerators

^(**) The model of the helium manifold depends on the branching shape of the helium lines.

3.5 Inspection of the compressor and accessories

Compressor

Inspect and visually confirm that there is no evidence of damage, oil leak and/or helium gas leakage to the compressor. If there is a problem, please contact our Service Engineering Division or the nearest customer support center.

Also check the value of helium pressure gauge on the front panel of the compressor to confirm that there is no helium gas leakage (Refer to “Section 5.1 Verification of helium static pressure”).

If the value of the helium pressure gauge indicates lower than the values in Table 1-5, adding helium gas is required. For the procedures of adding helium gas refer to “Section 7.3 Adjusting system helium pressure”.

Please contact our Service Engineering Division or the nearest customer support center if the helium static pressure is significantly low.

Accessories

Inspect and visually confirm the accessories that there is no evidence of damage. If any damage is found, please contact our Service Engineering Division or the nearest customer support center.

3.6 Flexible hoses and specifications

Flexible hose (Helium flexible line) consists of helium gas filled flexible hose, and self-sealing couplings at both ends.

Listed below are the specifications of flexible hoses.

Table 3-3 Flexible hose specifications

Item	Specification
Helium gas	99.999% pure or more
Allowable helium pressure	Max.2.45MPaG
Maximum operating temperature	70°C
Material	SUS304
Standard length	3m
Minimum bending radius	250mm
Coupling	1/2inch self-sealing coupling
Tightening torque of coupling	20N·m

<Note> The content of “Specifications and Drawings” specific to your system supersedes, if provided



CAUTION

Minimum bend radius of the flexible hose is 250mm.

Do not twist the flexible hose especially at both ends. Also, when bending the flexible hose ensure that no part of it becomes flattened.

Do not put any objects on the flexible hose.

Leave the dust caps on the self-sealing couplings of the compressor until the flexible hoses are connected to the couplings.

Failure to observe this warning may result in damage and/or break down of the equipment.



CAUTION

When carrying flexible hoses, keep appropriate bend radius. When storing them, avoid corrosion and condensation in the same manner to handle other equipment.

This page intentionally left blank.

Section 4 Equipment Installation, Piping, and Wiring

4.1	Before installation.....	4-1
4.2	Connecting cooling water piping	4-2
4.3	Connecting and disconnecting helium flexible hoses	4-2
4.4	Single cryopump installation	4-4
4.5	Multiple cryopump installation.....	4-5
4.6	Electrical connections	4-7
4.7	Wire routing for compressor and other equipments.....	4-13

4.1 Before installation

This section describes appropriate procedure for installing C30VR and connecting the compressor to a CRYO-U® cryopump. The procedure of connecting the compressor to a CRYO-T super trap is the same as connecting to a cryopump; however please refer to the relevant manual.

Figure 4-1 is the block diagram for the compressor installation.

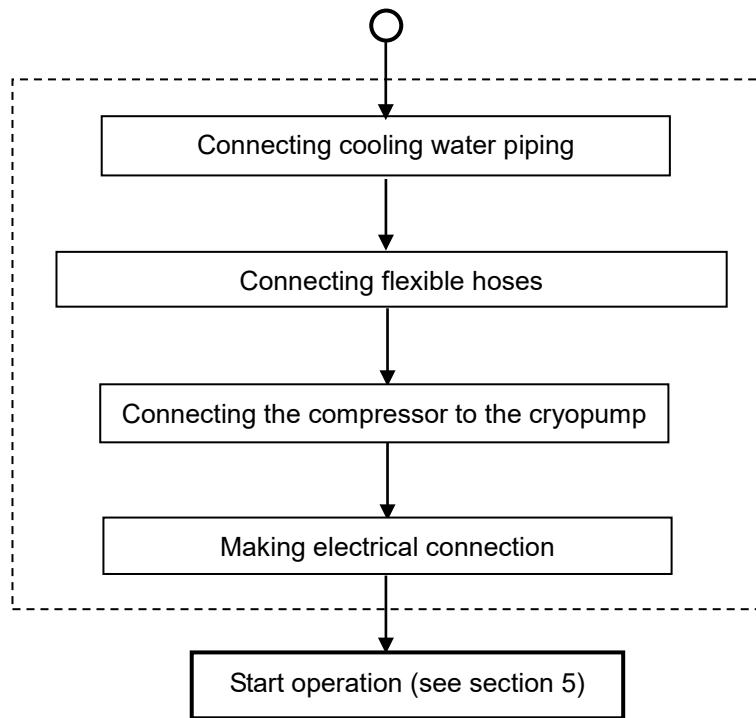



Figure 4-1 Installation procedure


CAUTION

To ensure safe, reliable system performance, read this manual as well as other relevant manuals completely to gain a thorough understanding before beginning work.

**CAUTION**

To ensure safe, reliable system performance, read this manual as well as other relevant manuals completely to gain a thorough understanding before beginning work.

4.2 Connecting cooling water piping**CAUTION**

Cooling water for this compressor must meet the requirements described in “Section 2-4 Cooling water requirements”. Failure to observe this warning may result in damage to and/or break down of the equipments.

Rc 3/8 female pipe threads are used for both cooling water inlet and outlet of the compressor.

The connecting procedures using fitting and hose (tube) are shown below.

1. Apply plumbing pipe sealing tape properly to screw side of the fitting.
2. Connect the fittings to “WATER IN” and “WATER OUT” with a spanner.
3. Connect the hoses to the fittings and fix the hoses properly with hose clamps.

**CAUTION**

Do not over-torque the hose fittings. It may damage the cooling water inlet or outlet.

4. Supply water via the cooling water piping at specified flow rate and ensure that there is no leakage.

To connect cooling water piping in any other way, follow the manual of the component.

4.3 Connecting and disconnecting helium flexible hoses**CAUTION**

Follow the procedures below to connect and disconnect flexible hoses. Failure to observe this warning may result in damage to the O-ring seals of the coupling and/or leakage of helium gas.

Connecting procedures

1. Remove all dust plugs and caps from the compressor, couplings and flexible hoses of the refrigerator. Check the connections and ensure that there is no dust or dirt on helium coupling gasket and around it. If there is any dust, remove it. Ensure that helium coupling gasket goes in the male coupling and there is no gasket for female coupling.
2. Return flexible hose is labeled "RETURN" with red letters. Connect the return flexible hose to "RETURN GAS" connector on the rear panel of the compressor. Then connect the other end of the return flexible hose to the connector labeled "RETURN" with red letters on the refrigerator side.

(Actual connecting method)

As shown in Figure 4-2, hold the braid support straight so that the connection parts fit properly and tighten by hands as tight as possible. Then tighten the coupling with two spanners as shown in Figure 4-3. See Figure 4-4 for usage of two spanners.

The torque value is 20N·m for both couplings. Complete the procedure as quick as possible to minimize helium gas leakage.



CAUTION

Tightening the couplings too much may result in equipment failure.

3. Supply flexible hose is labeled "SUPPLY" with green letters. Connect the supply flexible hose to "SUPPLY GAS" connector on the rear panel of the compressor. Then connect the other end of the supply flexible hose to the connector labeled "SUPPLY" with green letters on the refrigerator side. Connecting method is the same as the return flexible hose.
4. Verify the helium filling pressure referring to "Section 5.1 Verification of helium static pressure".



Figure 4-2 Tighten with hands first

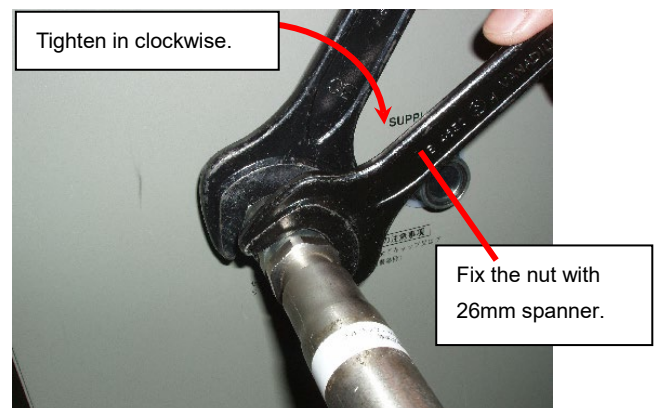


Figure 4-3 Tighten with two spanners

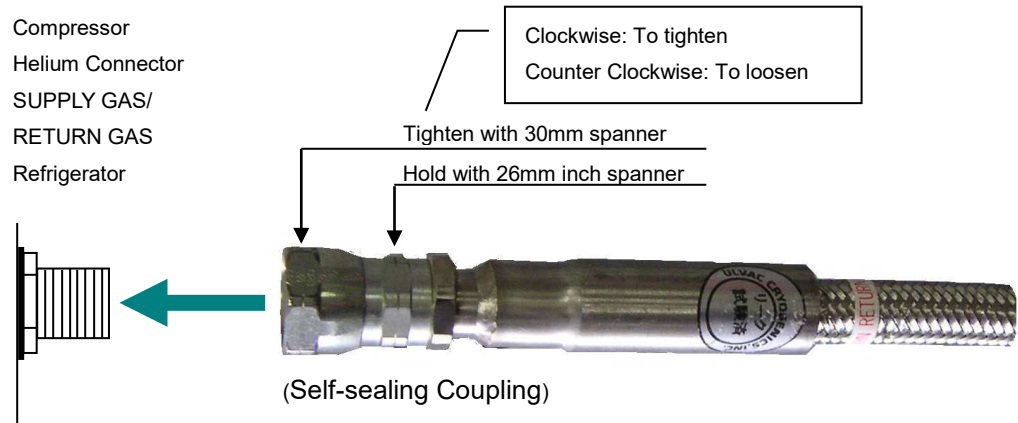


Figure 4-4 Connecting and disconnecting helium flexible hoses to compressor and refrigerator

Disconnecting procedures



CAUTION

If the flexible hoses are disconnected while the cryopump is still cold, the pressure inside the refrigerator will rise as its goes up and cause helium leakage via the pressure relief valve.

To disconnect flexible hoses from the connectors, use only two lipped bowl spanners (bolt width 26mm, 30mm). Do not use other spanners.

Loosen the couplings with two spanners and then take them off by both hands. Complete the procedure as quick as possible to minimize helium gas leakage.

4.4 Single cryopump installation

Figure 4-5 shows the connection of the compressor and single cryopump. Connecting procedures are below.

1. Connect flexible hoses to the compressor unit and to the cryopump as described in "Section 4.3 Connecting and disconnecting helium flexible hoses"
2. Connect the refrigerator cable to the compressor rear panel and the refrigerator. The procedures are shown below.

Connect the smaller refrigerator cable plug to the refrigerator receptacle. For a 2 phase motor refrigerator, the plug is self-locking. Fit the plug to the receptacle connection and push the plug while turning it to lock it. For a 3 phase motor refrigerator, insert the plug into the receptacle and then turn the rotating part of the plug to the right. Turn it until it won't turn any more to connect the plug properly. Connect the bigger refrigerator cable plug to the compressor receptacle. Connect the plug to "COLD HEAD POWER NO.1" receptacle on the rear panel of the

compressor and then turn the rotating part of the plug to the right. Turn it until it won't turn any more to connect the plug properly.

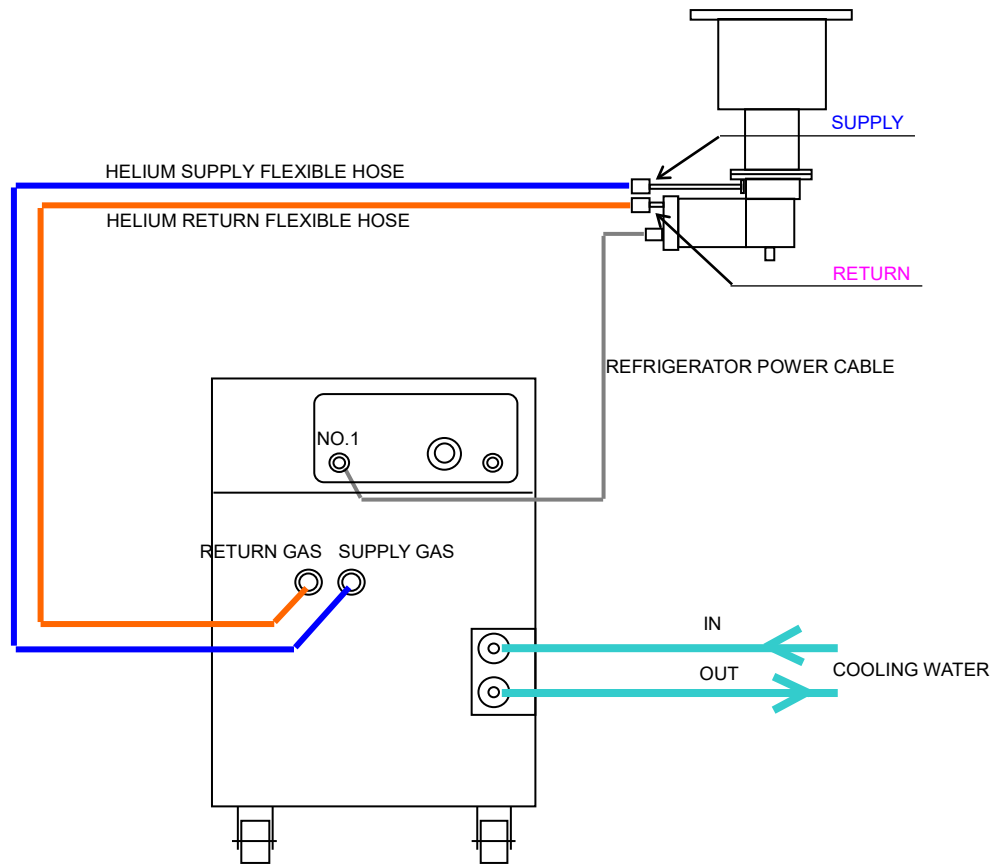


Figure 4-5 Connections of the compressor and single cryopump

4.5 Multiple cryopump installation

Figure 4-6 shows the connection of the compressor and multiple cryopumps.

1. First, install helium manifolds to the compressor connectors to connect multiple flexible hoses.
Refer to "Section 4.3 Connecting and disconnecting helium flexible hoses" for the method of installing manifolds as it is the same as connecting flexible hose to the compressor.
Connect flexible hoses to manifolds and to the refrigerators.
2. Connect the refrigerator cables from the rear panel of the compressor to the multiple cryopumps.

Connecting method is the same as the refrigerator cable connecting method described in "Section 4.4 Single cryopump installation".

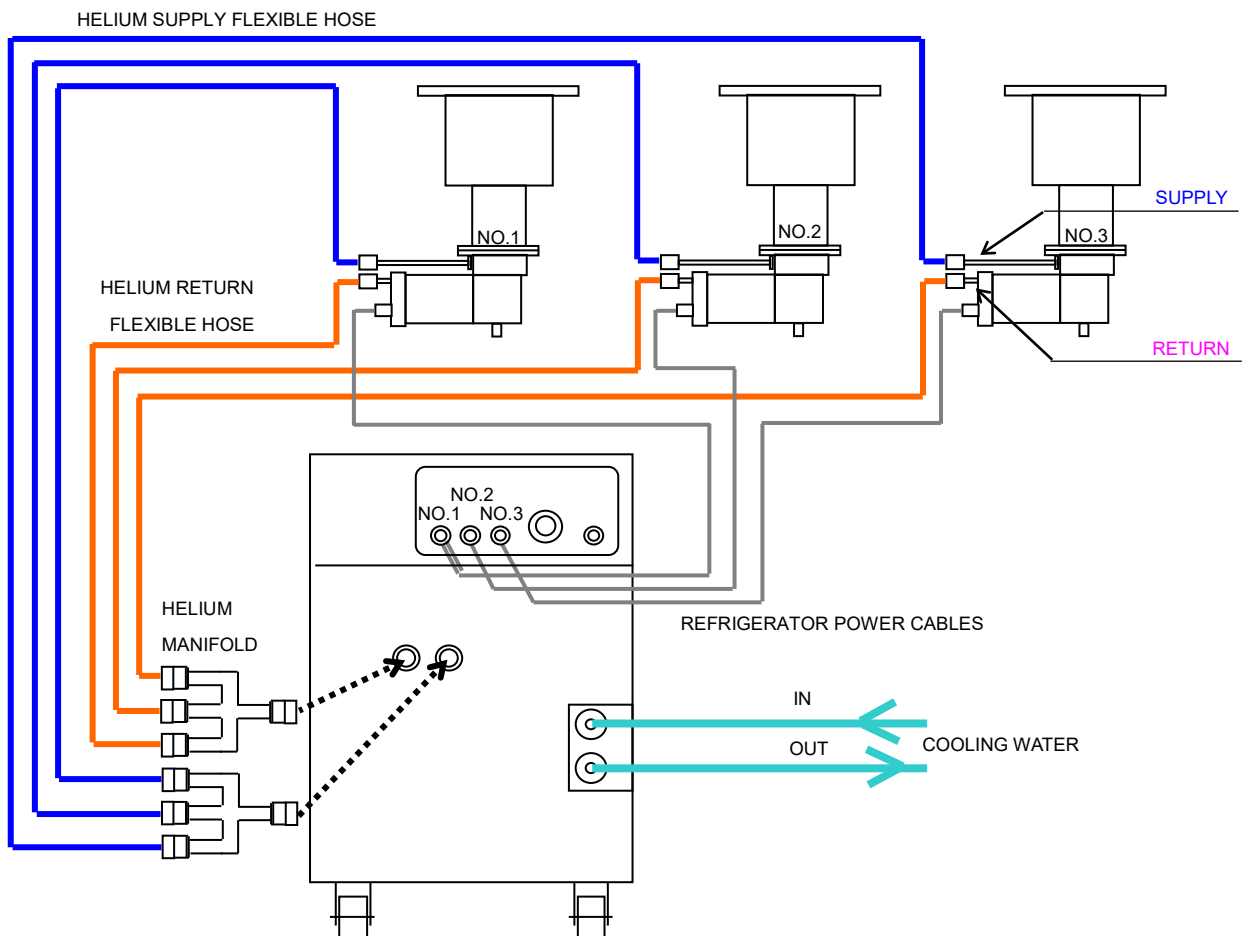


Figure 4-6 Connections of the compressor and multiple cryopumps (example with three cryopumps)

4.6 Electrical connections

Refer to “Single cryopump installation” in previous page to connect the refrigerator cable. Below are the connecting procedures of input power cable and remote input/output cable.



CAUTION

The electrical wiring must be done in accordance with all applicable local, national, and international standards. Failure to observe this warning may result in damage to and/or break down of the equipments.



WARNING

There is a danger of high voltage. Ensure that the input power source is OFF and locked before connecting or disconnecting input power cable. The wiring work must be undertaken only by an authorized electrician familiar with the structure and the risk of this equipment. Failure to observe this warning may result in severe bodily injury or fatal accident.

Refer to “Section 2.3 Wiring requirements” and confirm the specifications of the input power cable and the customer-supplied power circuit at the equipment side.

Ensure that the breaker which supplies power to the compressor has been turned off on the distribution board at the equipment side before connecting the input power cable.

To use a lock key to keep the power off status is effective as a fail safe.

4.6.1 Connecting the input power cable

Be sure to connect the input power cable first to the compressor and then to the circuit breaker of input power supply source. Wiring connection at power supply side must be done properly in accordance with the specifications of customer-supplied equipments. Connect ground wire as well (D class grounding).

Connect the plug of the input power cable to the compressor receptacle. After connecting the plug to the “INPUT POWER” receptacle on the rear panel of the compressor, turn the rotating part of the plug to the right. Turn it until it won't turn any more to connect the plug properly.

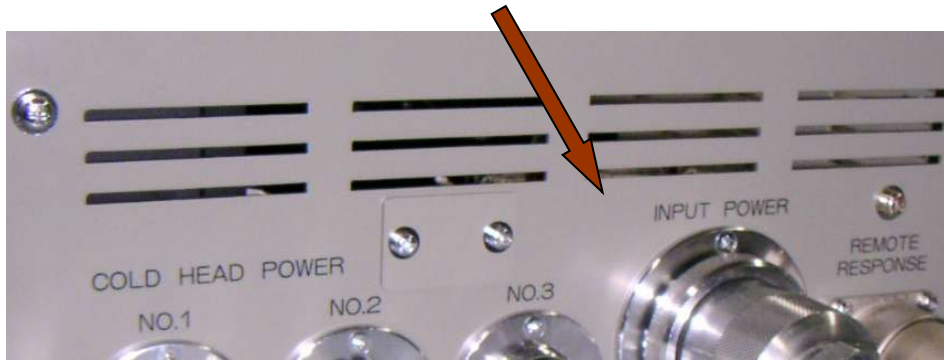



Figure 4-7 Connecting input power cable connector

4.6.2 Connecting remote cables

Figures 4-8 and 4-9 show connector pin assignments for remote cables. Necessary remote cables should be soldered to the connectors. Refer to “Section 2.3 Wiring requirements” and “Section 2.6 Remote functions” for remote cable specifications and remote functions respectively.



CAUTION

Remote cables must be wired only by authorized electrician familiar with the structure and operation of this equipment. Failure to observe this warning may result in damage to and/or break down of the equipment.

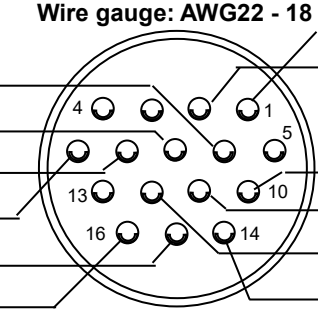
Input Signal	PIN No.	C30V R REMOTE/RESPONSE	PIN No.	Output Signal
		Wire gauge: AWG22 - 18	1	ALARM1
COMP START	6		2	ALARM2
COM	7		1	COMP RUN1
COMP STOP	8		11	COMP RUN2
COM	9		1	(Reserved for Factory test)
COMP ON/OFF	1		1	(GND)
COM	1			
			(SRCN6A25-16P)	

Figure 4-8 Remote connector pin assignments for C30VR
(View of from the plug soldering side)

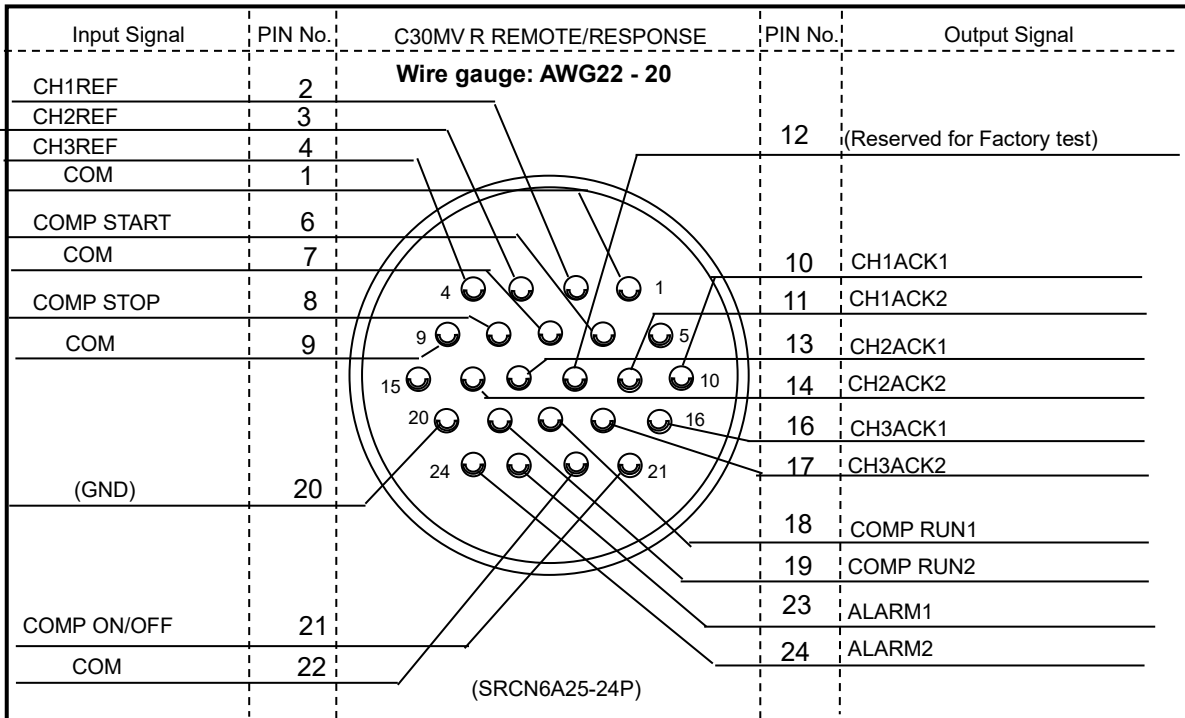


Figure 4-9 Remote connector pin assignments for C30MVR
(View of from the plug soldering side)

A typical wiring for C30VR with a single cryopump in “Alternate operating mode” is shown in Figure 4-10. Also, a typical wiring for C30MVR with three cryopumps in “Momentary operating mode” is shown in Figure 4-11.

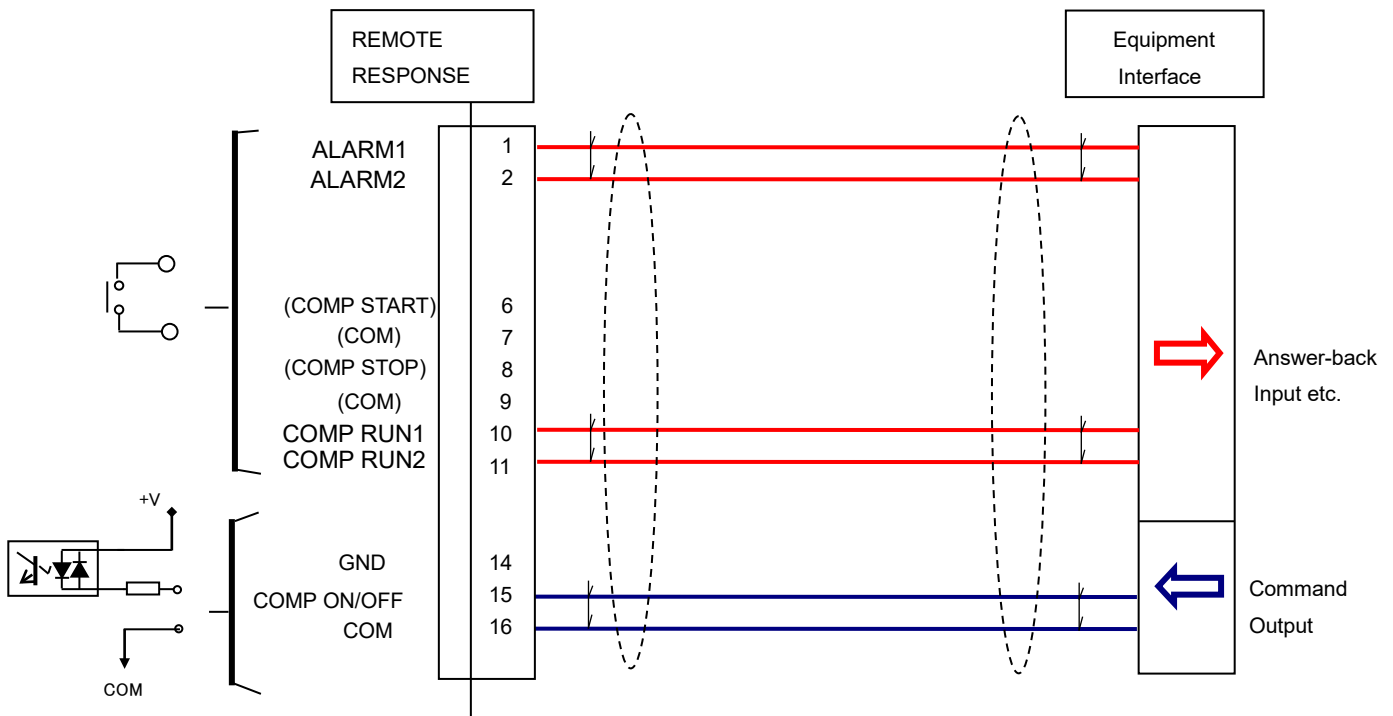


Figure 4-10 (C30VR) “Alternate operating mode” wiring example for Single cryopump operation

C30VR wiring precautions

- (1) In Alternate operating mode, the pins number 15 and 16 should be wired as operation command signals but not 6, 7, 8 and 9.
Conversely, in Momentary operating mode the pins number 6, 7, 8, and 9 should be wired as operation command signals but not 15 and 16. Therefore choose appropriate wiring depending on the operating mode.
- (2) Wire GND (pin number 14) only when it is needed. GND has the same electric potential as the compressor chassis. Connecting ground wire that has different power line (such as AC400V) from the compressor power supply line may cause overcurrent or noise problem due to a ground-loop.
- (3) Twist each signal line with a nearby COM line. (e.g.: Twist pin number 15 and 16)
- (4) COM lines are used as return lines of nearby signal lines. Therefore it is necessary to wire all the COM line which corresponds to the signal line, not to use just one COM line.
- (5) Twist paired signal lines such as COMP RUN1 and COMP RUN2.
- (6) These are signal lines. Do not drive the power device by direct output signals (such as answer-back signals) from the compressor. It may cause a failure of the product.

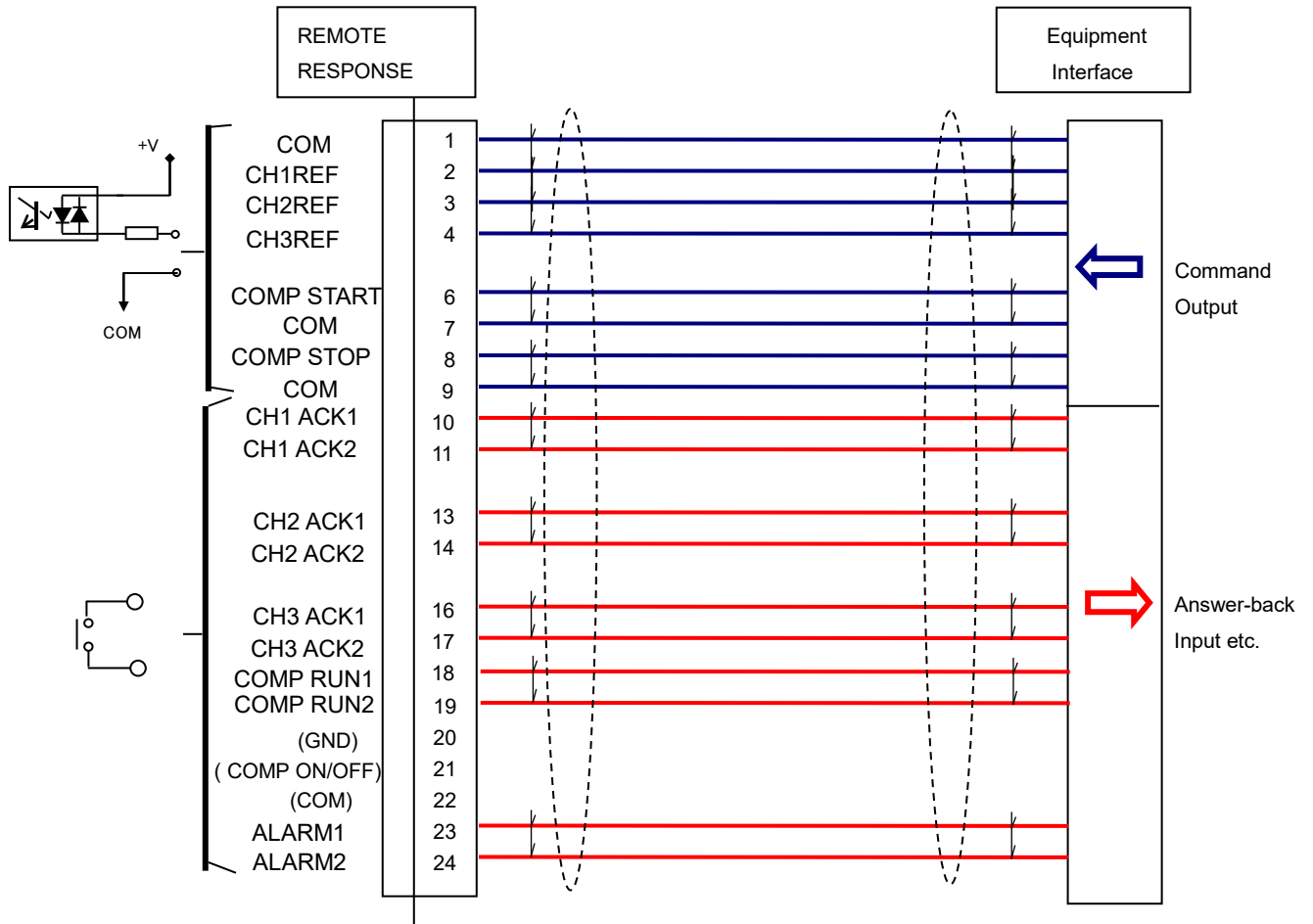


Figure 4-11 (C30MVR) "Momentary operating mode" wiring example for Multiple cryopumps operation

C30MVR wiring precautions

- (1) CH1REF, CH2REF, and CH3REF share COM of pin number 1.
- (2) In Momentary operating mode the pins number 6, 7, 8, and 9 should be wired as operation command signals but not 21 and 22.
Conversely, in Alternate operating mode the pins number 21 and 22 should be wired as operation command signals but not 6, 7, 8, and 9. Therefore choose appropriate wiring depending on the operating mode.
- (3) Wire GND (pin number 20) only when it is needed. GND has the same electric potential as the compressor chassis. Connecting ground wire that has different power line (such as AC400V) from the compressor power supply line may cause overcurrent or noise problem due to a ground-loop.
- (4) Twist each signal line with a nearby COM line. (e.g.: Twist pin number 6 and 7)
- (5) COM lines are used as return lines of nearby signal lines. Therefore it is necessary to wire all the COM line which corresponds to the signal line, not to use just one COM line.
- (6) Twist paired signal lines such as CH1ACK1 and CH1ACK2.
- (7) These are signal lines. Do not drive the power device by direct output signals (such as answer-back signals) from the compressor. It may cause a failure of the product.

Remote connector wiring procedure

Descriptions of the connector are shown in Figure 4-12.

(Taking apart a connector)

1. Loosen the set screw for the end bell fixation counterclockwise, and then take the end bell off from the connector body by turning it.
2. Remove the clamp saddle.

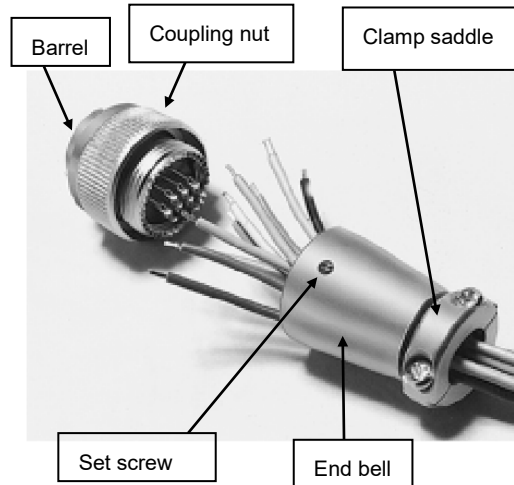


Figure 4-12 Connector parts descriptions

(Connecting cables)

3. Peel off the insulating coating to expose the proper length of the conductor. (Figure 4-13)
4. Pass the cables through the end bell and then solder the cables to the connector pins. Cover the soldered parts with heat shrinkable tubing.
5. If the bundle of the cables' diameter is smaller than that of the clamp saddle, wrap cables with tape to adjust the size of diameter so that it can be fixed in the clamp saddle.

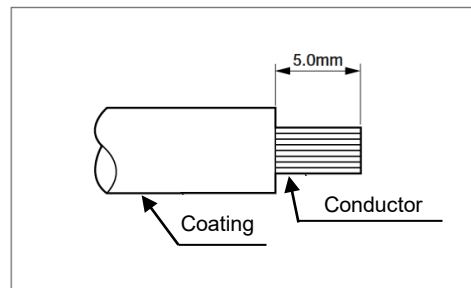


Figure 4-13 Cut length of insulation coating

(Assembling the connector)

6. Assemble the connector to the barrel by turning it.
7. Turn the set screw in clockwise to fix the end bell. (Figure 4-14)
8. Mount the clamp saddle.



Figure 4-14 Fix with set screw

(Solder identification)

9. Put the solder identification label on the connector or cables.



CAUTION

For lead-free soldering, use only specified lead-free solder iron and tip. Do not mix lead eutectic solder with lead-free solder. Failure to observe this warning may result in decreasing the life of soldered parts severely.

NOTE: Clear identification of solder: Listed below are the recommended abbreviations for identifying solders. Labeling the kind of solder clearly helps you to have proper maintenance.

Lead eutectic solder **SnPb** or **SP**

Lead-free solder (Sn-Ag) **SnAgCu** or **SAC**

Lead-free solder (Sn-Cu) **SnCuNi** or **SCN**



CAUTION

Connector must be soldered by authorized personnel familiar with the kinds of solder and soldering procedure. Failure to observe this warning may result in breakdown of the product, or decrease the life of soldered parts severely.

Connecting remote cable

Connect the cable plug to the compressor receptacle. After connecting the plug to the “REMOTE RESPONSE” receptacle on the rear panel of the compressor, turn the rotating part (coupling nut) of the plug to the right. Turn it until it won't turn any more to connect the plug properly.

4.7 Wire routing for compressor and other equipments

The compressor and other equipments must be wired in accordance with applicable local and national standards where the equipments are installed as well as international standards (e.g., NEC/CEC). Signal wires, sequence control wires, and power wires for connecting equipments must be wired in separate conduits to prevent interference during the operation.

In addition, analog wire is sensitive to and susceptible to noise, it must be separated from other wirings in the method above.



CAUTION

The remote wires must not be either put in the same conduit or routed with the power wires. It may cause interference with the compressor operation. Failure to observe this warning may result in damage to and/or break down of the equipment.

If it is impossible to wire in separated conduits, keeping enough distance between those wires can be effective as “separating wires”. Interference between wires depends on electromagnetic force but in general it is effective to keep the distance of 300mm or more between each wiring.

Note: Electromagnetic interference where the C30VR system, consists of the compressor and the refrigerator, effect to other equipments is not critical, however if the wiring of C30VR system is not separated from other equipments it may cause interference to sensitive sensor wires, analog wires, and other high impedance wiring of other equipments.

This page intentionally left blank.

Section 5 Operation

5.1	Verification of helium static pressure.....	5-1
5.2	Compressor operation.....	5-2
5.3	Inspection after replacing helium circulation components.....	5-4
5.4	Precautions for when compressor is not in operation.....	5-5
5.5	Maintenance operation for a compressor suspended for a long period.....	5-5

5.1 Verification of helium static pressure

Before starting cryopump system operation verify the helium static pressure.

Main components that make a system such as a compressor, flexible hoses, and a refrigerator have been charged with helium gas before they are shipped from the factory. However the helium pressure may be changed at the time of connecting the components.

Pressure verification procedure is shown below.

1. Stop the compressor if it is in operation and wait until the whole system has reached to the room temperature (It will take about three hours if the compressor has just been stopped).
2. Ensure that the flexible hoses between the compressor and the refrigerator are connected properly.
3. See Figure 5-1 and check the proper helium filling pressure value at the actual room temperature.
4. Make sure that the helium pressure shown in the high-pressure side pressure gauge on the front panel is in the range of $\pm 0.04\text{MpaG}$ to the above proper value.

It is possible to start operating the compressor when the helium filling pressure is in the proper range. If it is out of range, see "Section 7.3 Adjusting system helium pressure" and adjust it.



CAUTION

Improper helium pressure may make the performance unstable, shorten the compressor motor life, and/or cause malfunction of the product.



CAUTION

If the helium filling pressure is higher than the set pressure for the pressure relief valve described in Appendix D, the pressure relief valve of the compressor or refrigerator may vent the surplus helium gas.

If the pressure relief valve blows, stop the operation and leave the compressor for several hours to ensure that the helium filling pressure is in the range which can be still operated. If the helium filling pressure is reduced, please contact us for maintenance.

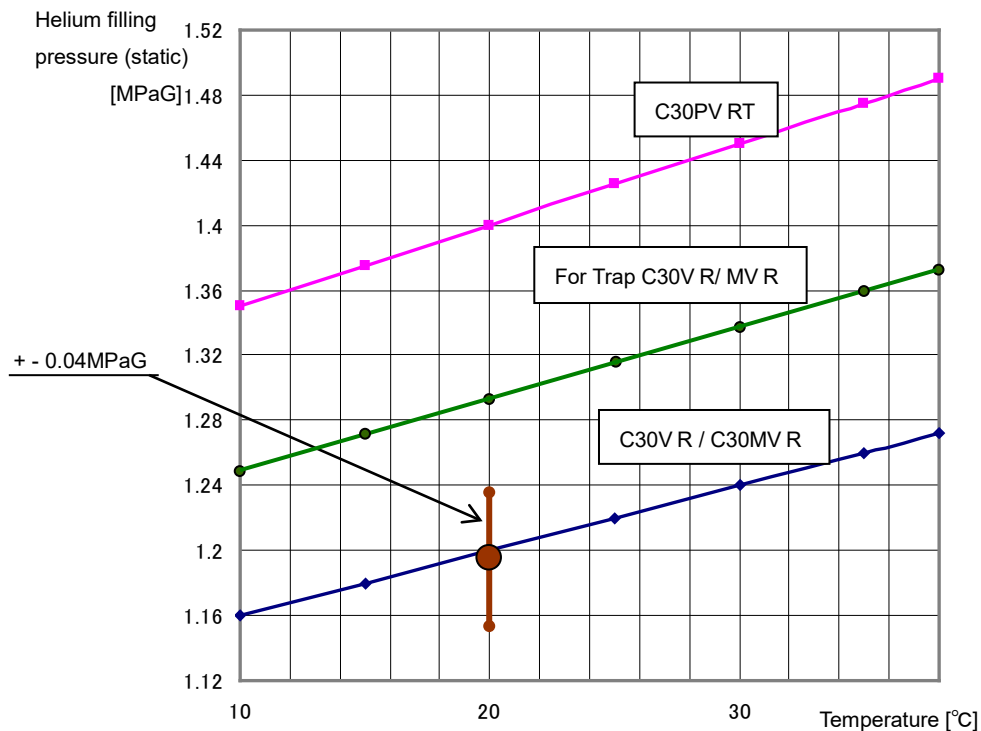


Figure 5-1 Helium static pressure and ambient temperature

5.2 Compressor operation

(1) Supply water to the cooling water piping

Supply water to the cooling water piping. After supplying cooling water, check that the water flow rate and the pressure are in the proper range (See “Section 2.4 Cooling water requirements”).

(2) Power-On the compressor



CAUTION

Power-On procedure and checking the main power phase sequence must be undertaken by an authorized electrician familiar with the construction and risk of this equipment. Failure to observe this warning may result in severe bodily injury or fatal accident.

Ensure that the compressor input power cable is connected to the INPUT POWER receptacle. Then turn on the breaker for the compressor inside the distribution panel at the equipment side.

The circuit protector in the compressor chassis is normally turned on; therefore the compressor will be powered on immediately by switching a power supply on the equipment side.

(3) Inspection of phase and voltage of an input power supply

If PWR LED and RDY LED indicators light up after a few seconds from power-on, the compressor is ready for operation (See Figure 5-2).

If the buzzer keeps ringing after power-on and all eight STS indicators light up, it means

that either the following faults has occurred; reversed phase of the input power cable, open phase or low voltage.

Figure 5-3 shows the display status described above.

If the phase is reversed or open, rewiring of the input power cable is required.

First, turn OFF the breaker for the compressor at the equipment side and cut off the power supply. Then check the order and colors of the wires of the input power cable to ensure that they are wired properly. If they are not correct, rewire them properly.

After the correction, power-on the compressor from the equipment side and check the STS indicators. If all STS indicators light up even though the phase sequence is correct, check if the power supply voltage and input power cable is normal or not.

Besides these statuses described above, if one of the STS indicators lights up and/or the buzzer sound does not stop, refer to “Section 8 Troubleshooting” to solve the problem.

		WARNING
<p>There is a danger of hazardous voltage. Only qualified electrical personnel familiar with the construction and risks of this equipment should perform procedure above.</p> <p>Failure to observe this precaution could result in severe bodily injury or loss of life</p>		



Figure 5-2 Ready for operation



Figure 5-3

Reversed phase or open phase

(4) Operation

Start operation of the compressor by remote function. Refer to “Section 2.6 Remote functions” for operation method by remote function.

(5) Operation status display

Figure 5-4 shows a status display during operation (C30MVR). While the compressor is in operation, RUN indicator lights up as well as the appropriate indicator(s) for refrigerator(s) which is in operation (CH1 indicator for C30VR and CH1, CH2, and CH3 indicators depends on the number of the refrigerator for C30MVR).



Figure 5-4 Status display during C30MVR operation

(6) Cryopump operation

The cryopump (refrigerator) operation can be started after pumping down the cryopump below 40Pa by a roughing pump (refer to cryopump manual for details). The cryopump condenses and adsorbs the gas molecules on its cryogenically-cooled panels (cryopanel). The compressor operates continuously throughout the cryo process.



CAUTION

The compressor is intended for continuous, not intermittent operation. The number of starting/stopping of the compressor pump must be six or less times per hour. Failure to observe this warning may result in damage to and/or life shortening of the compressor.

(7) Recording the helium pressure during operation

Helium high-pressure side pressure gauge on the front panel indicates the pressure of the helium supply line of the compressor.

Read the maximum pressure value at the time of starting the compressor operation.

Keep the cryopump system operating and read the pressure value of helium pressure gauge when the system is pumping steadily.

Write down these values in the Appendix A Table A-1, operating log sheet.

These two recorded values depend on the length of flexible hoses and a kind of the refrigerator mounted on the cryopump system. The recorded values are used as reference value for maintenance or replacement of the product explained in the following .

For reference, the helium pressure during operation of C30MVR (refrigerator R10 series) and C30PVRT (refrigerator R80 series) with 3m flexible hoses are shown in Table 5-1.

Table 5-1 Supply line helium pressure during operation

Quantity of refrigerator	C30MVR + R10/R10R/RM10 Refrigerator			C30PVRT + R80/R80RT/RM80T Refrigerator
	1	2	3	1
Helium Pressure at Start-up [MPaG]	Below 2.1			Below 2.3
Helium temperature when cryogenically cooled [MPaG]	1.6 - 1.8	1.65 - 1.75	1.5 - 1.6	1.9 - 2.0
(Remarks)				
1. Length of helium flexible hose : Standard (3m)				
2. Room Temperature : 20°C				

5.3 Inspection after replacing helium circulation components

After replacing a component such as a cryopump, a flexible hose, and a compressor refer to “Section 5.1 Verification of helium static pressure” and check that the helium filling pressure is almost equal to the value before replacing the component.

In addition, if the system installation condition has been changed, conduct “Recording the helium pressure during the operation” described above.

5.4 Precautions for when compressor is not in operation

If the temperature of cooling water supplied to the compressor is less than 10°C, stop the water supply after the compressor has been stopped. If cooling water of temperature below 10°C is supplied continuously it may increase viscosity of lubricant oil and cause start up failure of the compressor when the operation command is sent.

Also, if the compressor will be stopped for long period, it is recommended to stop supplying cooling water to avoid corrosion or clogging of the pipes inside the compressor and the heat exchanger. In addition remove the water from the compressor when needed (Refer to “Section 6.1.1 Removal of cooling water piping” to remove the water from the compressor).

5.5 Maintenance operation for a compressor suspended for a long period



CAUTION

When the cryopump system is suspended for a long period, operate the compressor for an hour every three months. This will supply lubricant oil to all the components inside the compressor. Also, operate the refrigerator for ten minutes at a time every six months. Failure to observe this precaution may result in damage to the compressor when restarting operation.

NOTE: Circulate cooling water as well during the maintenance operation of the compressor.

This page intentionally left blank.

Section 6 Wiring and Piping Removal and Storage

- 6.1 Removal of wiring and piping and displacement of compressor6-1
 6.2 Maintenance in storage6-2

6.1 Removal of wiring and piping and displacement of compressor

It is necessary to remove the cooling water piping, helium lines, and electrical wiring before changing the compressor installation place or removing the system.



CAUTION

The following replacing procedure must be undertaken by authorized personnel familiar with the structure and risk of the product. Failure to observe this warning may result in severe bodily injury or fatal accident.



WARNING

Inside the compressor unit, some areas remain hot immediately after the shutdown. Wait for at least 15 minutes in order to perform maintenance work safely. Failure to observe this warning may result in severe body injury.

Before starting removing work, ensure that the breaker for the compressor inside the distribution panel at the equipment side is OFF and lock it in the OFF position.

6.1.1 Removal of cooling water piping

Stop supplying cooling water to the compressor.

Drain water out from the compressor before removing the cooling water piping. Also, other than the purpose for removing the cooling water piping, drain water out from the compressor under the conditions listed below.

[Cooling water freezing]: When there is a danger of bursting cooling water piping due to freezing of the cooling water in the compressor.

[Long term halt]: When the cryopump system is stopped for more than a week for holidays or other reasons.

[Transfer]: When relocating the compressor.

(Cooling water draining procedure)

The following procedure is available only for an open loop type cooling-water supply system where the water outlet is opened to the atmosphere.

For close loop type cooling-water supply system, it is recommended to additionally install

a water drain line diverged from the water return line on the equipment in order to release water pressure in the compressor.

1. Stop supplying cooling water to the compressor unit and stop the water flow.
2. Disconnect the water supply pipe from the "COOLING WATER IN" fitting on the compressor. DO NOT disconnect the water pipe from the "COOLING WATER OUT" fitting. Note that cooling water might drip from the pipe when disconnecting it.
3. Connect a hose for air blowing to the "COOLING WATER IN" fitting.
4. Increase the air pressure inside the hose from 0 to 0.2MPaG. Keep air blowing for more than 30 seconds to blow out the water inside the compressor (The water goes out from the compressor through the water pipe at the "COOLING WATER OUT" fitting).
5. Stop air blowing.
6. Disconnect the hose for air blowing from the "COOLING WATER IN" fitting.
7. When transferring the compressor to other location, disconnect the water pipe from the "COOLING WATER OUT" fitting as well.



CAUTION

Do not perform the removing procedure above when the compressor is turned ON or cooling water is being supplied. Failure to observe this warning may result in severe bodily injury or fatal accident.

6.1.2 Disconnecting flexible hoses

To disconnect flexible hoses from the compressor, refer to "Section 4.3 Connecting and disconnecting helium flexible hoses".

Put the dust caps or dust plugs back on the compressor and the removed flexible hoses to keep them in storage.

6.1.3 Disconnecting cables

Disconnect the refrigerator cable from the refrigerator. It is not necessary to disconnect the refrigerator cable from the compressor.

Disconnect input-output remote cables from the compressor side.

Disconnect the input power cable from the compressor. Refer to "Section 4.6.1 Connecting the input power cable" and disconnect the cable in reverse order.

6.1.4 Transferring the compressor

Unlock the casters of the compressor.

When transferring the compressor, refer to warnings and precautions in "Section 3.3 Unpacking".

6.2 Maintenance in storage

The compressor must be stored in a place indoors and meet the requirements in "Section 1 Table 1-5 Installation environment and operation requirements". Also the storage

place chosen must be with good ventilation to avoid suffocation in case of unexpected helium leak.

Place the compressor on a flat floor and lock all the casters.

Remove the piping and wiring from the compressor and put dust caps or dust plugs on the helium line connectors.

Protect the removed components such as flexible hoses and cables with covers or boxes. Store them with the compressor.

Ensure that cooling water has been completely drained out from the compressor.

To store the compressor, cover it with a plastic sheet or package cardboard. Before storing the compressor, write down the value of the helium pressure gauge. Check the value and record it once a month. If the value is clearly decreasing compared to the one before, there is a possibility of helium leakage. Please contact our Service Engineering Division or the nearest customer support center.

This page intentionally left blank.

Section 7 Maintenance

- 7.1 Scheduled maintenance..... 7-1
- 7.2 Replacement of adsorber..... 7-1
- 7.3 Adjusting system helium pressure..... 7-5
- 7.4 Regular maintenance of helium lines, cooling water piping
and electrical wiring..... 7-10
- 7.5 Maintenance parts..... 7-10

7.1 Scheduled maintenance

The table below shows the required maintenance on the cryopump system. Refer to the following paragraph for details of adsorber replacement.

For maintenance of refrigerator or other components of the cryopump, see cryopump instruction manual.

Table 7-1 Scheduled maintenance

Item	Maintenance Cycle (h)
Adsorber replacement	24000h (longest)
Refrigerator maintenance	When needed (See cryopump instruction manual.)
Inspection for line connections and wirings	12000h



CAUTION

If the scheduled maintenance is not performed as required, it may result in shorter life, damage or failure of the cryopump system.

NOTE: If a special maintenance plan for your specific application is needed please consult with our Service Engineering Division or the nearest customer support center.

NOTE: Refer to “Disposal Considerations” when disposing used components or parts.

7.2 Replacement of adsorber



CAUTION

The following replacing procedure must be undertaken by authorized personnel familiar with the structure and risk of the product. Failure to observe this warning may result in severe bodily injury or fatal accident.

**WARNING**

Inside the compressor unit, some areas remain hot immediately after the shutdown. Wait for at least 15 minutes in order to perform maintenance work safely. Failure to observe this warning may result in severe body injury.

When adjusting helium pressure, it is necessary to perform the work while inside of the compressor unit is in room temperature. Perform this work after cooling down the compressor for three hours.

Adsorber replacement procedure is shown below.

1. Ensure that each equipment and device in cryopump system is safe to replace adsorber.
2. Turn off the compressor unit by turning OFF the breaker inside the distribution panel at the equipment side. Lock the breaker in the OFF status for safety reasons.
3. Disconnect the flexible hoses from the "SUPPLY GAS" and "RETURN GAS" connectors at the rear panel of the compressor. Observe the disconnecting requirements below. Refer to "Section 4.3 Connecting and disconnecting helium flexible hoses" for disconnecting method.

**CAUTION**

Do not disconnect flexible hoses while the cryopump is in low temperature. Doing so may raise the internal pressure as inside of the refrigerator unit warms up, resulting in helium leakage by activated safety valve.

NOTE: When disconnecting flexible hoses from the connectors, use two single-ended wrenches (bolt width 26mm, 30mm).

4. Remove the nuts of the connectors at the rear panel of the compressor with the spanner (Figure 7-1).
5. Remove the seven screws of the rear panel with a proper screw driver and remove the rear panel (Figure 7-2 and 7-3).
6. Disconnect the self-sealing coupling from the adsorber with two spanners. The coupling is connected to the flexible hose above the bottom plate inside the compressor chassis (Figure 7-4). See Figure 7-5 for usage of spanners to disconnect the coupling. Disconnect the coupling quickly to minimize minor helium leakage.
7. Remove the bolts that secure the adsorber to the base of the compressor with the proper spanner (Figure 7-6).

8. Slide the adsorber outward and remove it from the mounting tab on the base of the compressor. And then remove the adsorber from the compressor (Figure 7-7).



Figure 7-1 Remove two nuts from the helium gas connectors

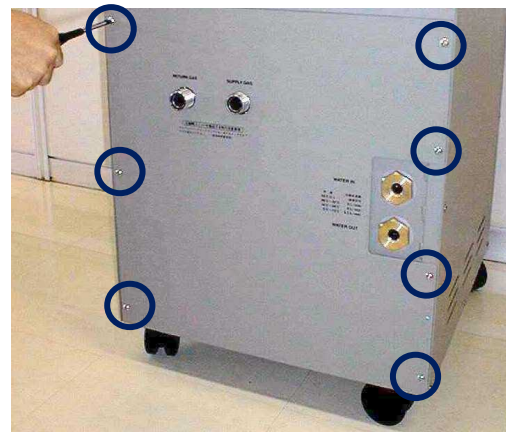


Figure 7-2 Remove all seven screws from the rear panel



Figure 7-3 Remove the rear panel

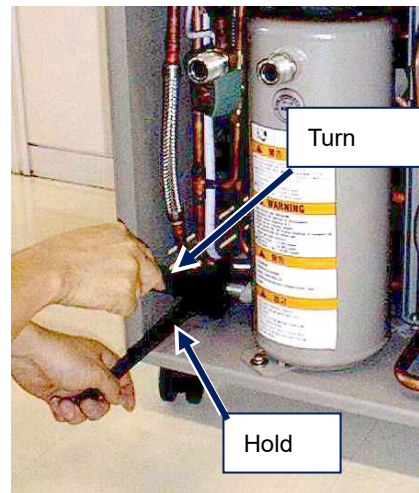


Figure 7-4 Remove self-sealing coupling

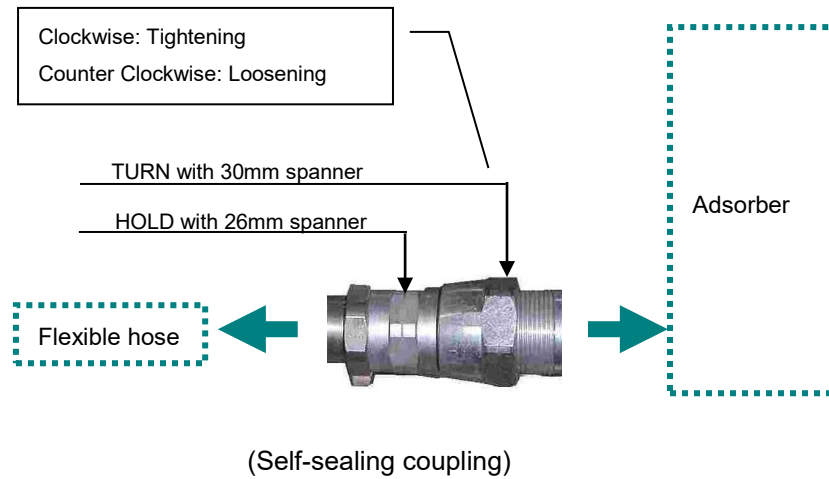


Figure 7-5 Connecting and disconnecting self-sealing coupling with two spanners



Figure 7-6 Remove adsorber mounting bolt



Figure 7-7 Slide adsorber outward

9. Install the replacement adsorber. Remove the two dust caps from the replacement adsorber. Put the adsorber into the compressor so as to place it at the mounting tab on the base of the compressor. Secure the adsorber with the mounting bolt temporarily.
10. Connect self-sealing coupling to the adsorber with the two spanners. Tighten the coupling referring to Figure 7-5. Recommended tightening torque is $20\text{N} \cdot \text{m}$. Connect the coupling quickly to minimize helium leakage.
11. Put the rear panel back on the compressor to align the helium connector of the adsorber with the hole of the rear panel and then remove the rear panel again. Fix the adsorber mounting bolt firmly this time.

12. Replace the rear panel and secure it by tightening the seven screws.
13. Put the two removed nuts back on to the “SUPPLY GAS” and “RETURN GAS” connectors at the rear panel of the compressor and tighten each nut using the two spanners supplied.
14. Connect the flexible hoses to the “SUPPLY GAS” and “RETURN GAS” connectors at the rear panel of the compressor. Refer to “Section 4.3 Connecting and disconnecting helium flexible hoses” for connecting method.
15. Check the helium static pressure. Refer to “Section 5.1 Verification of helium static pressure”.
If the pressure is higher or lower than it should be, adjust it referring to the following “Section 7.3 Adjusting system helium pressure”.
16. Record the date and accumulated operation time when the adsorber was replaced in the adsorber replacement record label on the front panel of the compressor.
As a guide for the next replacement, it is recommended to make a note of the value that the current accumulated operation time added to the adsorber replacement cycle hours in Table 7-1.
Refer to “Disposal Considerations” when disposing used adsorber.

7.3 Adjusting system helium pressure

System helium pressure must be adjusted when the compressor is not in operation. Refer to “Section 5.1 Verification of helium static pressure” for prescribed standard pressure value when the compressor is not in operation. Prescribed standard pressure value while the compressor is in operation is the value recorded at “Section 5.2 Compressor operation, (7) Recording the helium pressure during the operation”.
If the pressure has changed to ± 0.04 or more MPaG from the prescribed standard value, follow the procedure below and adjust the system pressure.



CAUTION

All helium circulation components must be connected when adjusting the pressure of the cryopump system.



WARNING

Following procedure must be undertaken by authorized electrician and mechanical personnel familiar with the construction and risk of this equipment. Failure to observe this warning may result in severe bodily injury or fatal accident.

**WARNING**

Immediately after the compressor is shut down, some areas inside may remain hot. Wait at least 15 minutes until it cools down to conduct the work safely. Failure to observe this warning may result in severe bodily injury.

Pressure adjustment must be done when the equipment inside the compressor are at room temperature. Wait for about three hours until it cools down before performing this work.

The following describes how to adjust the helium pressure.

(1) Reducing the helium pressure

1. Using an appropriate screw driver, unscrew the six screws at the front panel of the compressor and remove the panel (See Figure 7-8).
2. Open the Helium fill valve inside the compressor slowly by turning its knob counter-clockwise. Release the small amount of helium gas.
3. Wait until the helium pressure gauge reads the prescribed standard value described above. When the pressure reaches the standard value, close the valve by turning its knob clockwise.
4. Replace the front panel of the compressor with the six screws.

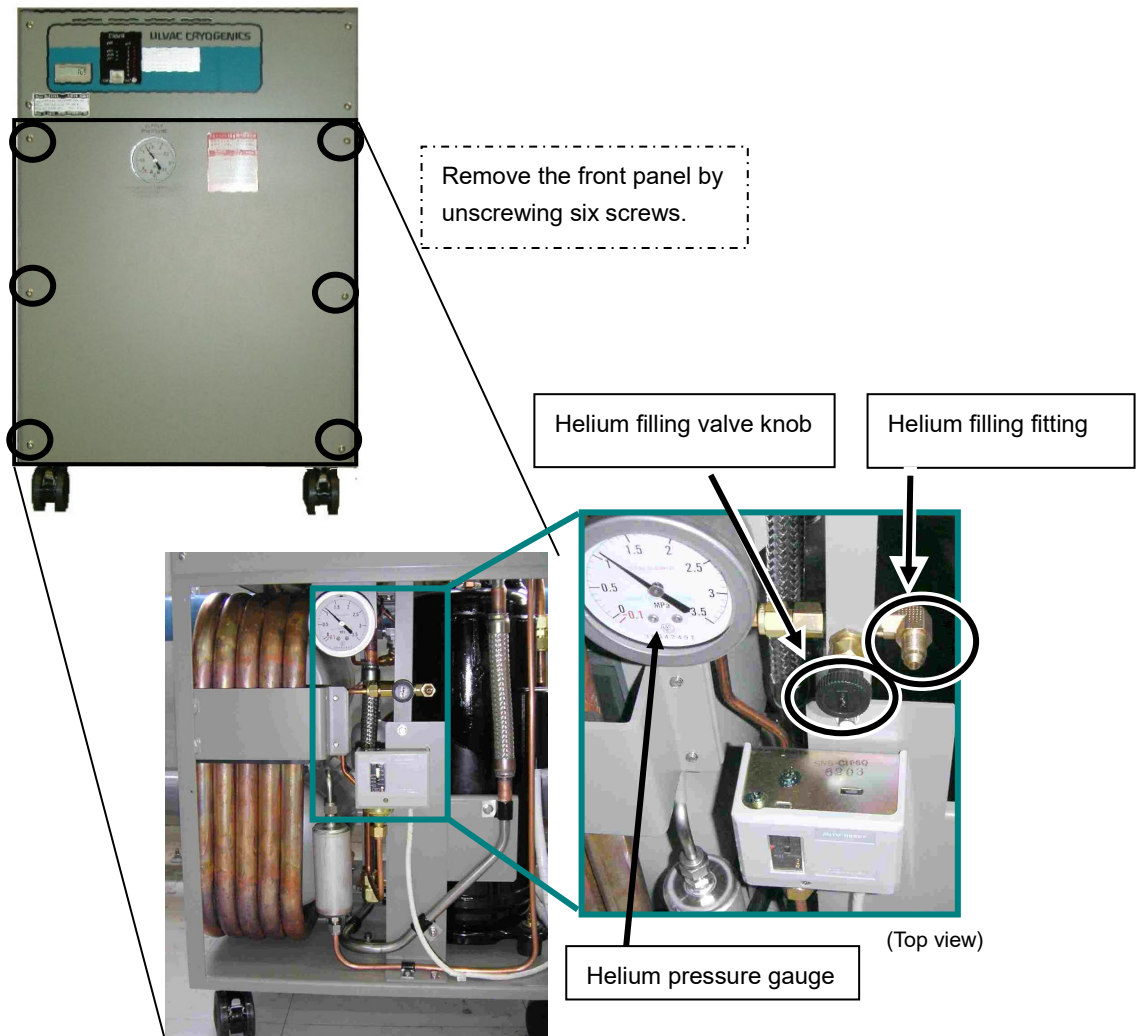


Figure 7-8 Locations of front panel screws and components inside the compressor

(2) Raising Helium Pressure

When the helium pressure gauge reads a value lower than the prescribed standard value, adding helium gas is required.

When charging helium or performing helium circuit decontamination, equipments (regulators, charging hoses, adopters, etc.) that can be used at 2.0MPaG or above are required.

Table 7-2 shows items and devices required for adding helium gas.

Table 7-2 Equipment requirement for adding helium gas

Item	Specification
Helium bottle	99.999% pure or above
Pressure regulator	For Helium gas (left-hand screw), Lower side gauge of 4-6MPaG
Helium charging hose	Terminating in a 1/4 inch female flare fitting

NOTE: If you need a pressure regulator and/or helium charging hose described in Table 6-2 for adding helium gas, please contact our Service Engineering Division or the nearest customer support center.



CAUTION

The purity of helium gas to be charged must be above 99.999%. If the purity is lower, it may result in deterioration of the cryopump system or performance degradation.



CAUTION

If the helium pressure of the cryopump system becomes 0, there is a risk that air or moisture in the air invade into the system and contaminate helium. In such a case, please contact our Service Engineering Division or the nearest customer support center.

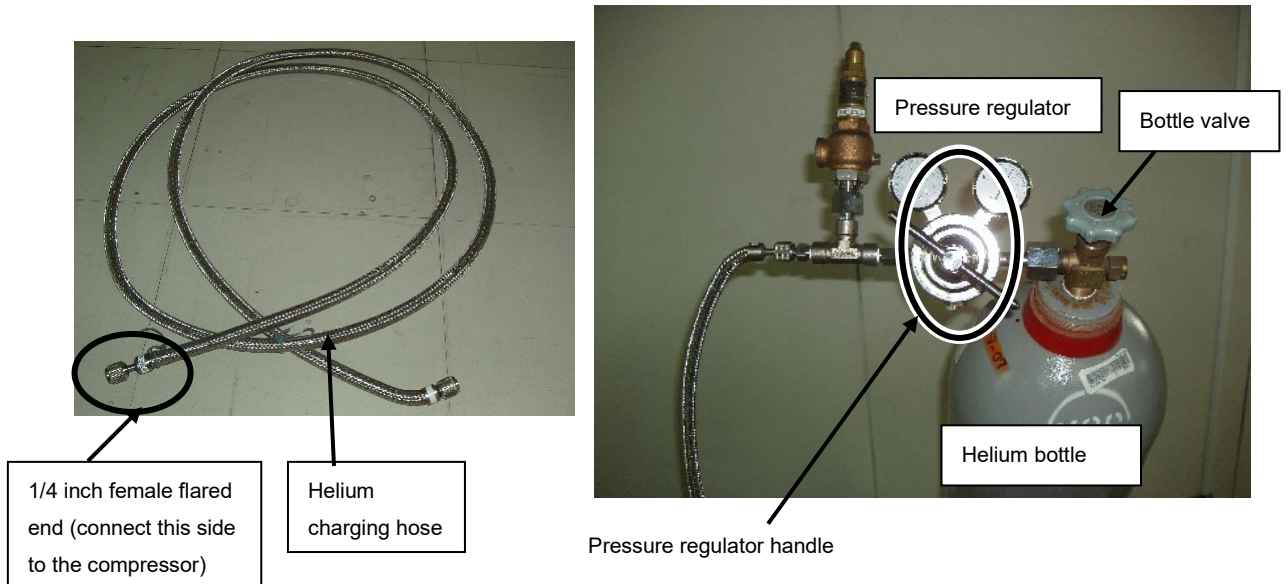


Figure 7-9

Items for adding helium gas to the compressor

Connecting helium supply line and air purging procedures

1. Remove the front panel of the compressor.
2. Attach the pressure regulator to a helium bottle.
3. Purge the pressure regulator and helium charging hose.
 - 3-1 Turn the pressure regulator handle in clockwise ^(*) slowly until it becomes hard to turn. Then turn approximately 1/8 to 1/6 more so that the pressure regulator is barely open.
 - 3-2 Slowly open the bottle valve, and confirm the helium gas is flowing out from the pressure regulator exit. After confirming the gas flow, close the pressure regulator by turning its handle counter-clockwise and then connect the helium charging hose to the pressure regulator.
 - 3-3 Turn the handle clockwise again and confirm the lower side pressure gauge indicates 0.1MPaG to 0.2MPaG. At this time, helium gas is flowing out from the flared fitting of the charging hose. Allow helium gas to flow for 30 seconds to purge the charging hose of air.

(*) In general, a pressure regulator opens by turning its handle clockwise.
4. Purge the helium filling fitting of the compressor and connect the charging hose.
 - 4-1 While doing the procedure in 3-3, open the helium filling valve slightly (turn it counter-clockwise). Allow a small amount helium gas to flow through the helium filling valve and the helium filling fitting to purge the air between them.
 - 4-2 Connect the 1/4 inch female flare end of the charging hose to the helium filling fitting of the compressor while the helium gas flows out from both the helium filling fitting and the charging hose.
 - 4-3 After connecting them, close the helium filling valve by turning its knob clockwise.

Filling helium gas to the compressor

1. Turn the pressure regulator handle attached to the helium bottle clockwise and adjust the pressure that the lower side pressure gauge indicates 1.8MPaG.
2. Open the helium filling valve by turning its knob slowly counter-clockwise. At the same time monitor the value indicated on the helium pressure gauge of the compressor goes up slowly.
3. When the helium pressure reached the prescribed standard value, close the helium filling valve by turning its knob clockwise.
4. Confirm that the valve is closed firmly. Turn the handle of the pressure regulator in counter-clockwise to stop the gas flow. Then disconnect the charging hose from the helium filling fitting of the compressor.
5. Replace the front panel of the compressor. Refer to the appearance of the front panel shown in Figure 7-8.

7.4 Regular maintenance of helium lines, cooling water piping and electrical wiring

Conduct inspection on helium lines, cooling water piping and electrical wiring every 12000 hours.

Inspect connection parts of helium lines and cooling water piping for evidence of leakage. Also check that there is no damage in these plumbing.

		WARNING
<p>Following procedure must be undertaken by authorized electrician and mechanical personnel familiar with the construction and risk of this equipment. Failure to observe this warning may result in severe bodily injury or fatal accident.</p>		

For electrical wiring, inspect the refrigerator cable of the compressor and remote input-output cable to ensure that they are connected firmly. At the inspection, turn off the compressor unit by turning OFF the breaker on the distribution panel at the equipment side. Lock the breaker at OFF status for safety reason. Disconnect the input power cable from the compressor.

7.5 Maintenance parts

Table 7-3 shows parts that need replacement during maintenance. Replace them when needed referring the replacing cycle in the table.

Table 7-3 Maintenance parts

Parts	Type ^(*)	Replacing cycle
Adsorber	S	Max. 24,000h
Gasket for helium coupling	U	When it is damaged or becomes dirty.
^(*) Maintenance type S: Scheduled U: Unscheduled		

NOTE: For more information on planning maintenance, purchasing maintenance parts, diagnosis, and servicing, please contact our Service Engineering Division or the nearest customer support center.

Section 8 Troubleshooting

8.1 Problem types..... 8-1
 8.2 Troubleshooting procedures..... 8-2
 8.3 Alarm code descriptions 8-4

8.1 Problem types

C30VR compressor indicates the state of warning or breakdown with a buzzer sound and STS indicators.

NOTE: When a problem occurs, check the status of STS indicators. Also, make sure that the power-supply voltage, cooling water flow rate and its temperature, helium gas pressure, input power cable connections, and the remote cable connections are all in an appropriate state.

There are eight indicators called “STS” at the front panel of the compressor. Please refer to Figure 8-1 for the alarm types of warnings and faults (The alarm status code table shown in Figure 8-2 is labeled on the compressor body).

NOTE: Ensure that all the operation command of the compressor is OFF while trouble shooting the compressor.

ALARM STATUS TABLE					
	STS	Description		STS	Description
1 ● 2 ● 3 ● 4 ● 5 ● 6 ● 7 ● 8 ●	1	Reverse Phase, Open Phase, Low Volt	1 ○ 2 ○ 3 ○ 4 ○ 5 ● 6 ● 7 ● 8 ●	5	LPS Low Helium Pressure
1 ○ 2 ● 3 ● 4 ● 5 ● 6 ● 7 ● 8 ●	2	TS2 Over Temperature	1 ○ 2 ○ 3 ○ 4 ○ 5 ○ 6 ● 7 ● 8 ●	6	CP2 Cold Head Trip
1 ○ 2 ○ 3 ● 4 ● 5 ● 6 ● 7 ● 8 ●	3	TS1 Over Temperature	1 ○ 2 ○ 3 ○ 4 ○ 5 ○ 6 ○ 7 ● 8 ●	7	OL1 Comp. Over Current
1 ○ 2 ○ 3 ○ 4 ● 5 ● 6 ● 7 ● 8 ●	4	TS3 Over Temperature	1 ○ 2 ○ 3 ○ 4 ○ 5 ○ 6 ○ 7 ○ 8 ●	8	Controller Fault

● → lit up ○ → off

Figure 8-1 Alarm status table

ALARM STATUS TABLE			
STS	Description	STS	Description
1	Reverse Phase, Low Volt	5	LPS Low Helium Pressure
2	TS2 Over Temperature	6	CP2 Cold Head Trip
3	TS1 Over Temperature	7	OL1 Comp. Over Current
4	TS3 Over Temperature	8	Controller Fault

Figure 8-2 Alarm status code table

8.2 Troubleshooting procedures

1. Troubles occurred before operation

Table 8-1 List of troubleshooting before operation

Problem	status	Possible cause	Corrective action
In power OFF state, Elapsed Time Meter display is dark.	Value indication is too pale to read or OFF.	Battery for Elapsed Time Meter went low (Battery life: more than 6 years).	Replace the Elapsed Time Meter. Call for servicing [※] .
“PWR” indicator does not light up.	Power failure	Input power voltage is lower than rated voltage, or open phase (S-T).	Check power supply and correct it.
	Power failure or CP1 malfunction.	CP1 protector trip.	Turn CP1 ON. If it trips again call for servicing [※] .
	Failure of power supply (DC24V) inside controller.	Blown fuse or power supply failure.	Call for servicing [※] .
“RDY” indicator is OFF.	“STS” indicators indicate ALARM status and buzzer activated.	Does not meet requirements to start operation or there is a failure.	See detailed alarm codes in the following section (8.3) and take corrective action.
“PWR” indicator and/or “STS” indicator blinks.	“STS” indicators indicate ALARM status and buzzer activated.	Input power voltage reduction, open phase, or equipment failure.	Check input power cable, breaker and power supply at equipment side. If there is no problem with either, call for servicing [※] .
Both “RDY” and “STS” indicators do not light up.	Compressor needs reset.	Abnormal behavior of compressor caused by power failure or other reasons.	Push “RST” button or Call for servicing [※] .

※If the problem is not solved, please contact our Service Engineering Division or the nearest customer support center.

2. Troubles during operation

Table 8-2 List of troubleshooting during operation

Problem	Status	Possible cause	Corrective action
“RDY” indicator is ON but remote operation cannot be performed.	Remote signal fault.	Remote input-output cable is not connected or connection of output signal from the equipment is wrong.	Correct pin number of output signal from the equipment and connect remote input-output cables properly.
Operation command is sent but compressor pump does not start up.	Both “RDY” and “RUN” indicators light up.	Compressor motor fault or disconnection of motor wiring.	Call for servicing [※] .
“RUN” indicator is ON but refrigerator is not running.	CH1, CH2, and CH3 indicators remain OFF.	Fault or improper connections of remote input-output cables.	If commands from the equipment side are correct, check remote input-output cables and their connection.
	CH1, CH2, and CH3 indicators are ON.	Too many impurities in helium gas.	Refer to cryopump manual.
		Power-supply voltage is too low.	Set power-supply voltage within the available range.
		Relay fault inside Controller or fault such as refrigerator cable disconnection.	Call for servicing [※] . Replace the refrigerator cable.
“RDY” indicator lights OFF and the compressor stopped running.	“STS” indicators light up and buzzer sounds.	Interlock is activated.	See detailed alarm codes in the following section (8.3) and take corrective action.
After a short electric power interruption, compressor does not start operation.	After a short electric power interruption, operation does not restart.	“Alternate operating mode” does not have restart function for short power interruption.	“Momentary operating mode” enables the compressor to restart if the electric power recovers within 2 seconds after interruption. If this function is required, change the operation mode by modification of remote wiring. Refer to Section 2 and Section 4.
	After power is interrupted for longer than 2 seconds, compressor does not start operation.	Longer electric power interruption than set time (2 seconds).	Compressor needs restart.

※ If the problem is not solved, please contact our Service Engineering Division or the nearest customer support center.



CAUTION

Troubleshooting procedures described above must be undertaken by an authorized electrician or mechanical personnel familiar with the structures and the risks of the compressor and its related components. To ensure safe, reliable system performance, read this manual as well as other relevant manuals completely to gain thorough understanding before beginning work.

When a compressor does not need power supply to follow the procedure, shut down the power of the compressor and lock it in the OFF status. Failure to observe this caution may result in severe bodily injury or fatal accident.

8.3 Alarm code descriptions

<Alarm status>

● → lit up ○ → off

STS

- 1 ●
- 2 ●
- 3 ●
- 4 ●
- 5 ●
- 6 ●
- 7 ●
- 8 ●

Reverse Phase, Open Phase, Low Volt

(Reverse phase, open Phase, or low voltage)

When the state of the compressor main power supply corresponds to following either and the state continues 3 seconds or more, all LED indicators light up.

1. Reverse phase
2. Open phase
3. Low voltage (in case of nominal 170V or less)

When a voltage drop arises at the time of starting, a compressor stops immediately, however the alarm is not turned on. It is because the voltage value returns to normal, shortly after stopping. In this case, a start and a stop might be repeated.

Check and make sure that the line voltages (R-S, S-T, and T-R) of the power cable are within the rated value. If these voltages are within the rated value and all indicators are light up, there is a possibility of reverse phase. Check the wiring of the main power supply referring to "Section 5.2(3) Checking the compressor status and main power phase sequence".

If the input power supply voltage is low, check the input power line and the user's power supply that has distributed electric power to the compressor.

When there is an open phase(s), all indicators should be blinked or turned off.

- 1 ○
- 2 ●
- 3 ●
- 4 ●
- 5 ●
- 6 ●
- 7 ●
- 8 ●

TS2 Over Temperature (Over temperature)

TS2 monitors the temperature of the compressor pump. If TS2 is activated it means the compressor pump is in an unrecoverable abnormal condition. Please contact our Service Engineering Division or the nearest customer support center immediately.

- 1 ○ **TS1 Over Temperature (Over temperature)**
 2 ○
 3 ● TS1 monitors the temperature of the helium supply line. If TS1 is activated it
 4 ● means the compressor is in an unrecoverable abnormal condition. please contact
 5 ● our Service Engineering Division or the nearest customer support center
 6 ● immediately.
 7 ●
 8 ●
- 1 ○ **TS3 Over Temperature (Over temperature)**
 2 ○ This temperature switch is activated when cooling water does not meet the
 3 ○ requirements and/or cooling water lines are not connected properly. Refer to
 4 ● "Section 2.4 Cooling water requirements" and ensure that the temperature and flow
 5 ● rate of cooling water are appropriate for the compressor specification. If they are
 6 ● not appropriate correct them to within the proper range. Wait 15 minutes for the
 7 ● temperature switch to recover and then push the "RST" button to clear the alarm.
 8 ●
- 1 ○ **LPS Low Helium Pressure (Reduction of helium pressure)**
 2 ○ This pressure switch monitors the pressure reduction in the helium return line.
 3 ○ When there is helium leakage or the helium filling pressure is lower than the preset
 4 ○ value, the switch will operate (The set pressure of this switch is 0.1 ± 0.02 MPaG).
 5 ● Check the connections of the flexible hoses and the helium filling pressure referring
 6 ● to "Section 4.3 Connecting and disconnecting helium flexible hoses" and "Section
 7 ● 5.1 Verification of helium static pressure". If the alarm is not cleared by the
 8 ● procedures above, please contact our Service Engineering Division or the nearest
 customer support center immediately.
- 1 ○ **CP2 Cold Head Trip (Overcurrent of refrigerator)**
 2 ○ When this alarm lights up, it means there is an over current in the refrigerator motor
 3 ○ circuit and the circuit protector (CP2) has been activated.
 4 ○ Turn OFF the compressor and check the compressor side, refrigerator cable, and
 5 ○ refrigerator motor for evidence of earth fault or short circuit.
 6 ● If there is an earth fault or short circuit in the parts above or no identified cause,
 7 ● Please contact our Service Engineering Division or the nearest customer support
 8 ● center.
 If the power supply voltage is abnormally high compared to the rated working
 voltage (Table1-3), it may cause an overcurrent on the refrigerator motor and the
 circuit protector (CP2) may activates.
- 1 ○ **OL1 Comp. Over Current (Overcurrent or open phase of compressor)**
 2 ○ This alarm is activated when OL1 detects an over current or open phase in the
 3 ○ compressor motor.
 4 ○ Check that the helium pressure is not higher than the set value on the helium
 5 ○ pressure gauge. Refer to "Section 5.1 Verification of helium static pressure" for
 6 ○ helium pressure set value and "Appendix C C30VR compressor electrical circuit"
 7 ● for OL1 set value.
 8 ● Turn OFF the power of the compressor for at least 5 minutes and then turn it ON
 again to clear the alarm. If the problem is not solved, please contact our Service
 Engineering Division or the nearest customer support center.

- 1 ○ **Controller Fault (Controller fault)**
2 ○ A control module constantly checks the hardware to maintain safe operation.
3 ○ When a component fault occurs in a part such as a magnetic contact (MC) during
4 ○ operation, this alarm is activated. Loose wiring in the controller could be a cause
5 ○ of the alarm also.
6 ○ Please contact our Service Engineering Division or the nearest customer support
7 ○ center for replacement and adjustment of the controller.
8 ●

- 1 ○ **Other (Status whereby both RDY and STS indicators are OFF)**
2 ○ In normal operation, RDY indicators light up and STS indicators are off. If both
3 ○ RDY and STS indicators are OFF, it means there is a fault other than those listed
4 ○ above. If the indicator shows the same status after pushing "RST" button and
5 ○ turning OFF and ON the power of the compressor, please contact our Service
6 ○ Engineering Division or the nearest customer support center for replacement and
7 ○ adjustment of the controller immediately.
8 ○

Appendix A Operating log

Table A-1 Operating log

CRYOPUMP S/N					CRYO-U® OPERATING LOG					POWER V × φ		
COMPRESSOR S/N												
REFRIGERATOR S/N												
Measuring condition					Compressor unit				Cryopump			Remarks
									Temperature		Pressure	
									1 st stage	2 nd stage		【Pa】
Date	Time	Measurer	Room temp. 【°C】	Humidity【%】	ETM	High pressure helium gas 【MPaG】	Current 【A】	Cooling water flow rate 【L/min(*)】	K thermocouple	MBS-C	H ₂ V/P etc	

(*) Measure cooling water flow rate with flow meters for each compressor unit.

This page intentionally left blank.

Appendix B Combination of C30VR Compressor and Cryopump/Super Trap

Table B-1 Combination of C30VR series compressor and cryopump/Super Trap

Type	Model	Size (inch)	Pump/Trap specifications		Maximum number of refrigerator per one compressor				
			Refrigerator		2-phase drive model		3-phase drive model		
			Model	Quantity	C30VR	C30MVR	C30VRT	C30MVRT	C30PVRT
CRYO PUMP	U4H	4	R10/R10R/RM10	1	1(*2)	3			
			R10T/R10RT/RM10T	1			3		
	U6H	6	R10/R10R/RM10	1	1(*2)	3			
			R10T/R10RT/RM10T	1			3		
	U8H,U8HSP, U8HL	8	R10/R10R/RM10	1	1(*2)	3			
			R10T/R10RT/RM10T	1			3		
	U10H,U10HL	10	R10/R10R/RM10	1	1(*3)	3			
			R10T/R10RT/RM10T	1			3		
	U12HSP,U12HL	12	R20/R20R/RM20	1	1	2			
			R20T/R20RT/RM20T	1			1	2	
	U16L	16	R20/R20R/RM20	1	1				
	U16P,U16PL	16	R50/R50R/RM50	1	1				
			R50T/R50RT/RM50T	1			1		
	U20P	20	R50/R50R/RM50	1	1				
U20H,U20HSP, U20HL	20	R80/R80R/RM80T	1					1	
		R80T/R80RT/RM80T	1					1	
U22H	22	R50/R50R/RM50	2	1(*1)					
		R50T/R50RT/RM50T	2			1(*1)			
U30H	30	R50/R50R/RM50	2	1(*1)					
		R50T/R50RT/RM50T	2			1(*1)			
SUPER TRAP	T4,T6,T8	4~8	RS10/RMS10	1	1(*2)	3			
			RS10T/RMS10T	1			3		
	T10	10	RS10/RMS10	1	1(*2)	3			
			RS10T/RMS10T	1			3		
			RS50/RM50	1	1				
	T12,T14,T16	12~16	RS50/RMS50	1	1				
			RS50T/RMS50T	1			1		
	T20	20	RS50/RM50	1	1				
			RS50T/RMS50T	1			1		
			RS80T/RMS80T	1				1	
	T22	22	RS80T/RMS80T	1				1	
	T32	32	RS80T/RMS80T	1				1	

NOTE: Depending on the operating condition, the number of refrigerators that one compressor unit can run may be different from below. Contact us for the detail.

*1 2 compressors are needed for single pump.

*2 It is possible to operate with C30VR series, however it is recommended to operate with a C10 compressor unit.

*3 It is possible to operate with C30VR series, however it is recommended to operate with a C15R compressor unit.

This page intentionally left blank.

Appendix C C30VR Schematic Diagram

Schematic diagrams of the C30VR compressor units are shown in Figure C-1 to Figure C-4.

In addition, variations of setting and connections are shown in Table C-1.

Table C-1 Differences on devices between compressor unit models

Figure	Model	OL1 setpoint	Refrigerator			Scott Transformer (3 to 2 phase)
			Cable	Connector	Max. quantity	
C-1	C30VR	26A	For 2 phase drive	For 2 phase drive	1	Installed
C-2	C30MVR				3	
C-3	C30PVRT	28A	For 3 phase drive	For 2 phase drive	1	Not Installed
C-3	C30VRT	26A			3	
C-4	C30MVRT					

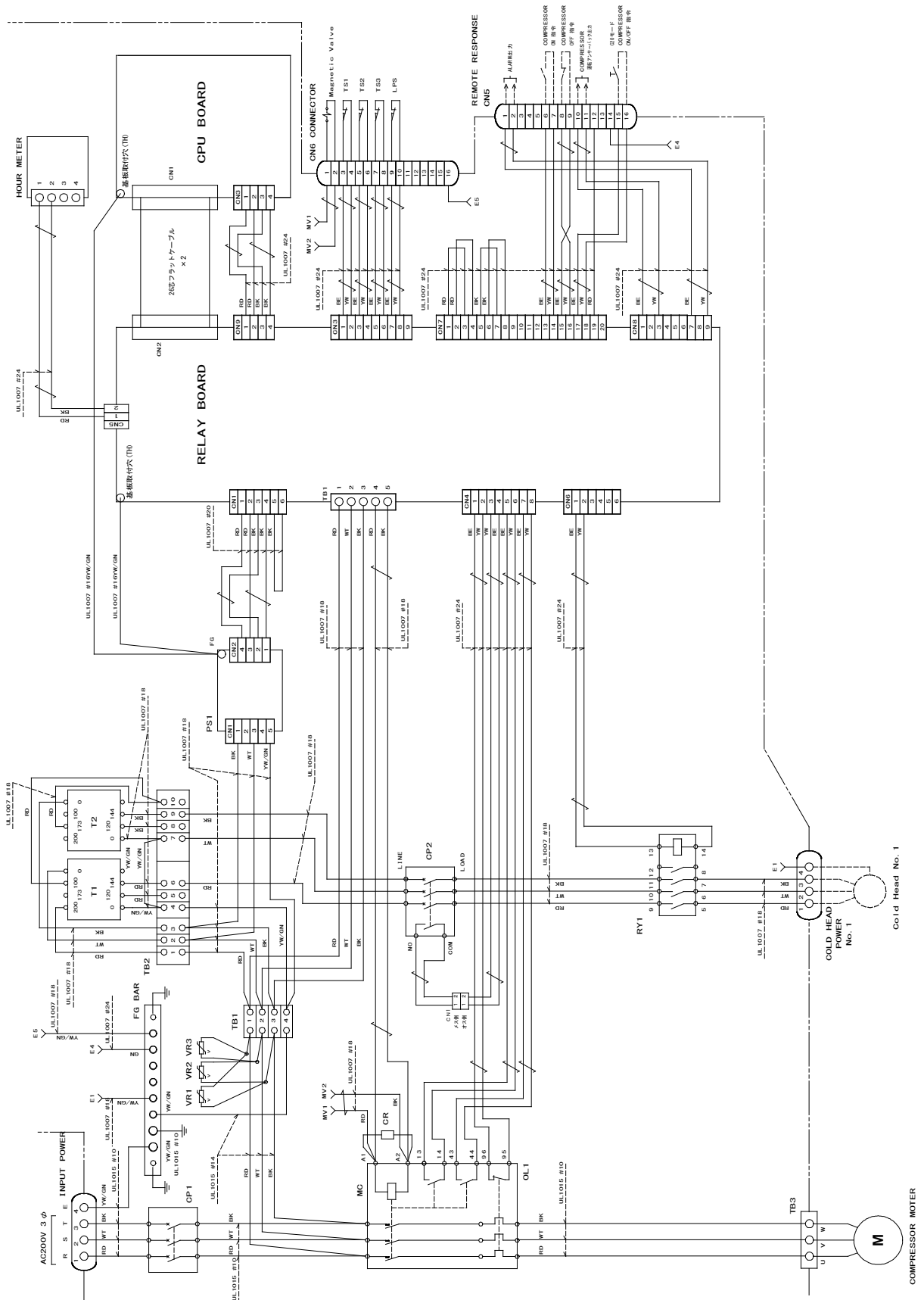
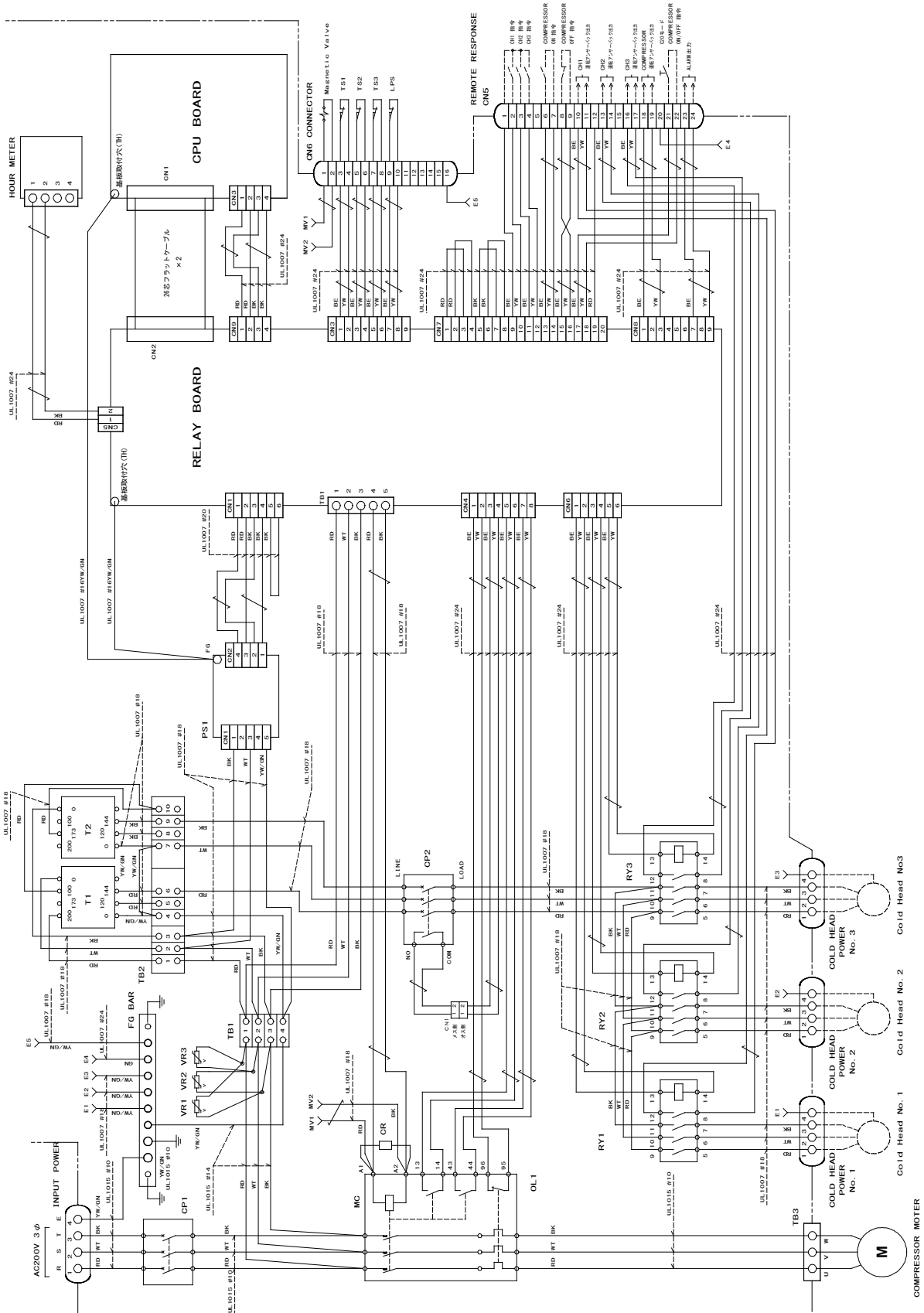


Figure C-1 C30VR schematic diagram



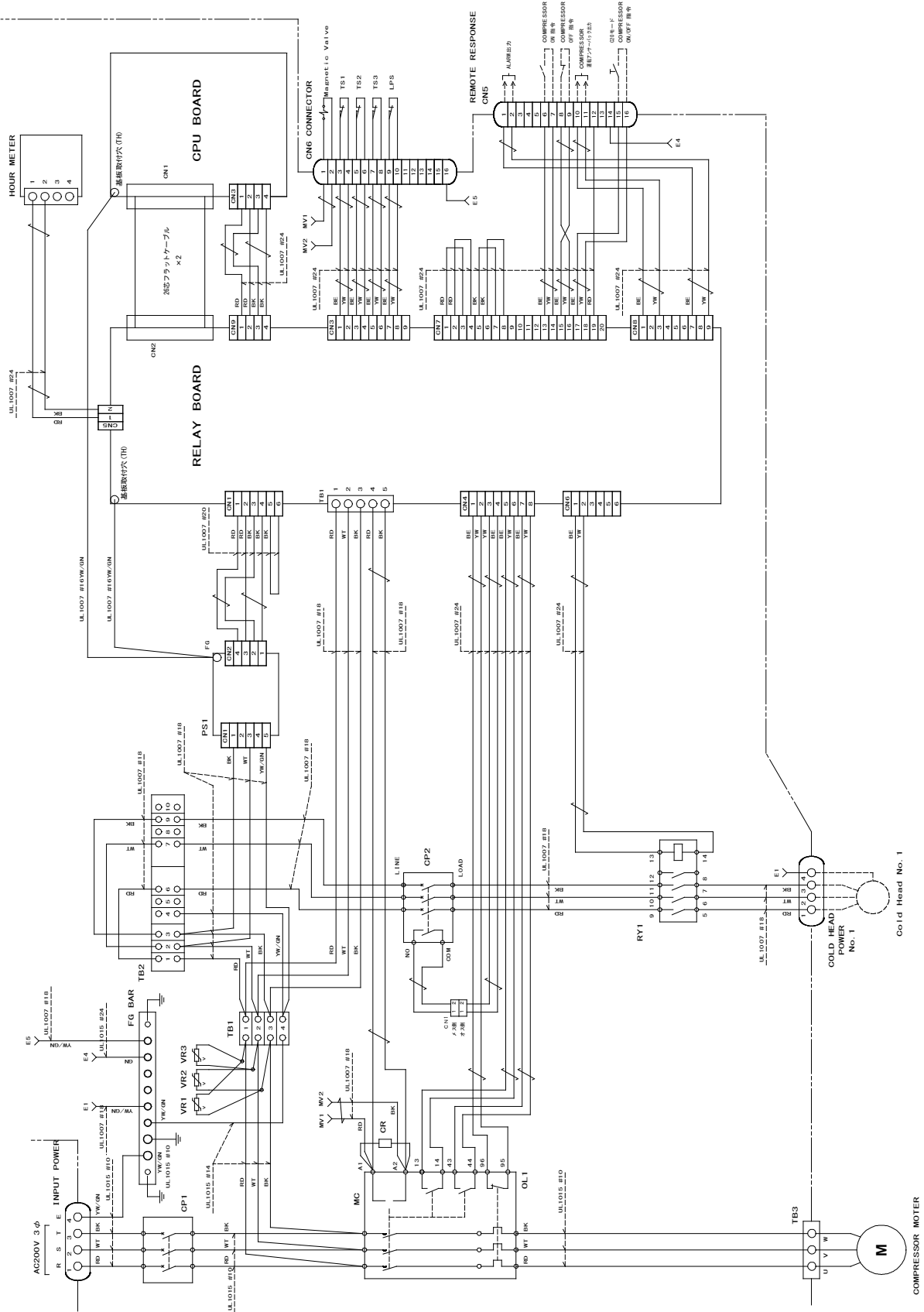


Figure C-3 C30VRT and C30PVRT schematic diagram

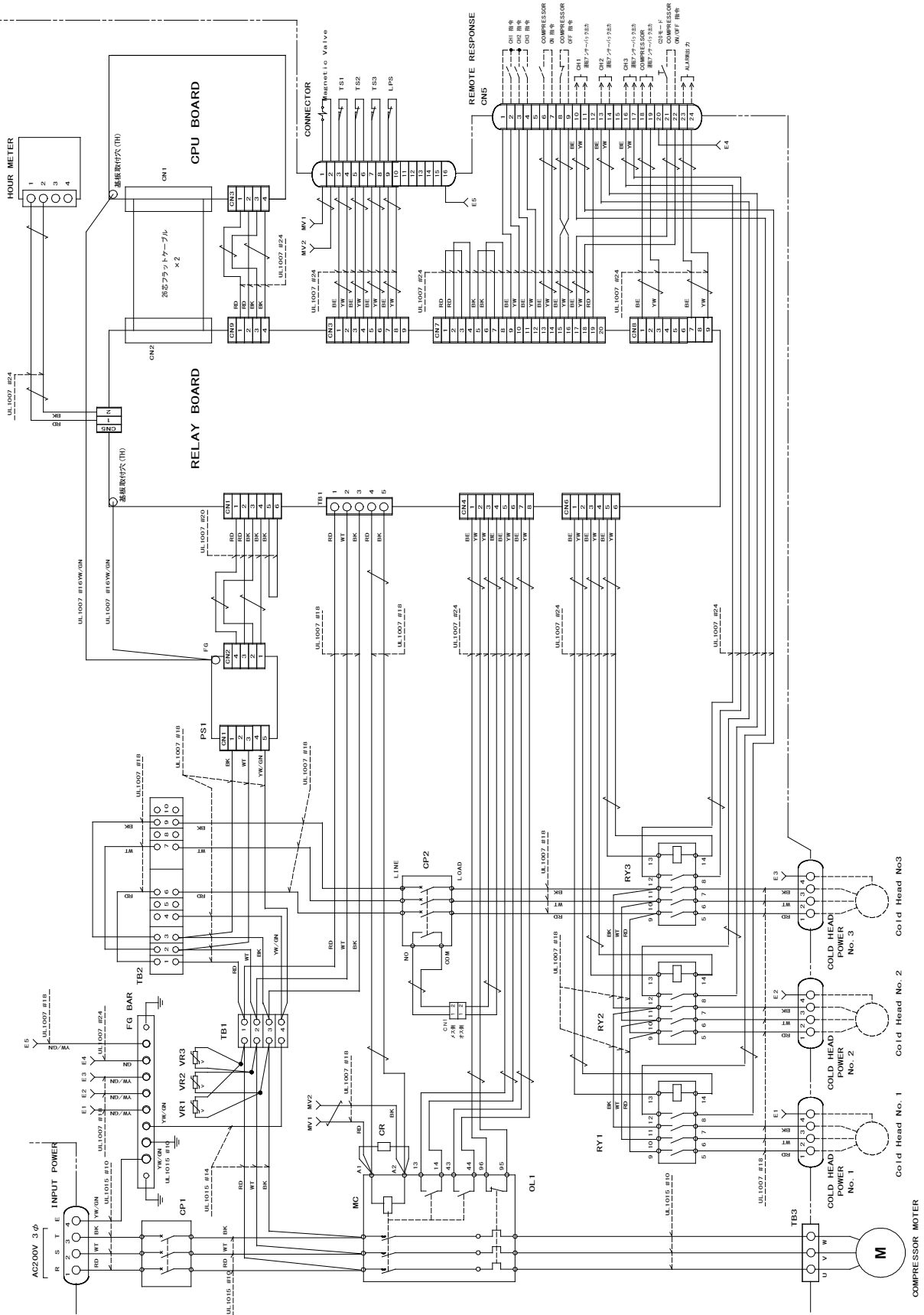


Figure C-4 C30MVRT schematic diagram

This page intentionally left blank.

Appendix D C30VR Compressor Flow Diagram

Low pressure helium gas returning from the refrigerator unit enters the compressor. Lubricant oil is injected into the compressor with the low pressure helium; the gas containing the oil is then compressed by the compressor pump turning it into high temperature high pressure helium gas. Most of the lubricant oil returns to droplet form and is separated within the compressor. This lubricant oil is pooled at the bottom and lubricates the inside of the compressor. It follows the circulating system where it comes out from the compressor and cooled down at an oil heat exchanger before being injected back into the compressor through an oil injection filter.

High temperature high pressure helium gas comes out from the compressor, passes through a water cooled helium heat exchanger for removal of compression-caused heat. It is cooled to an ambient temperature and then enters an oil separator. In here, the oil is separated and the droplets of separated oil pass through an oil return filter and oil return orifice before joining the low pressure helium gas and being returned to the compressor. High pressure helium gas comes out from the oil separator enters an adsorber where oil-mist is adsorbed and removed. The Helium gas comes out the adsorber passes through a flexible hose and is supplied to the refrigerator unit.

◆ Compressor safety devices

Name	Function	Specification
Pressure relief valve ※1	Located on the helium supply line and releases gas automatically when pressure exceeds the set value.	Set pressure : 2.85MPaG
Differential pressure regulating valve	Located on the line connecting helium supply and return lines and automatically keeps the high - low differential pressure under the set value.	Set pressure : 1.74MPa

※1 The set pressure of pressure relief valve at the refrigerator is 1.9MPaG. Please note that the refrigerator pressure relief valve releases gas before the compressor pressure relief valve in actual system.

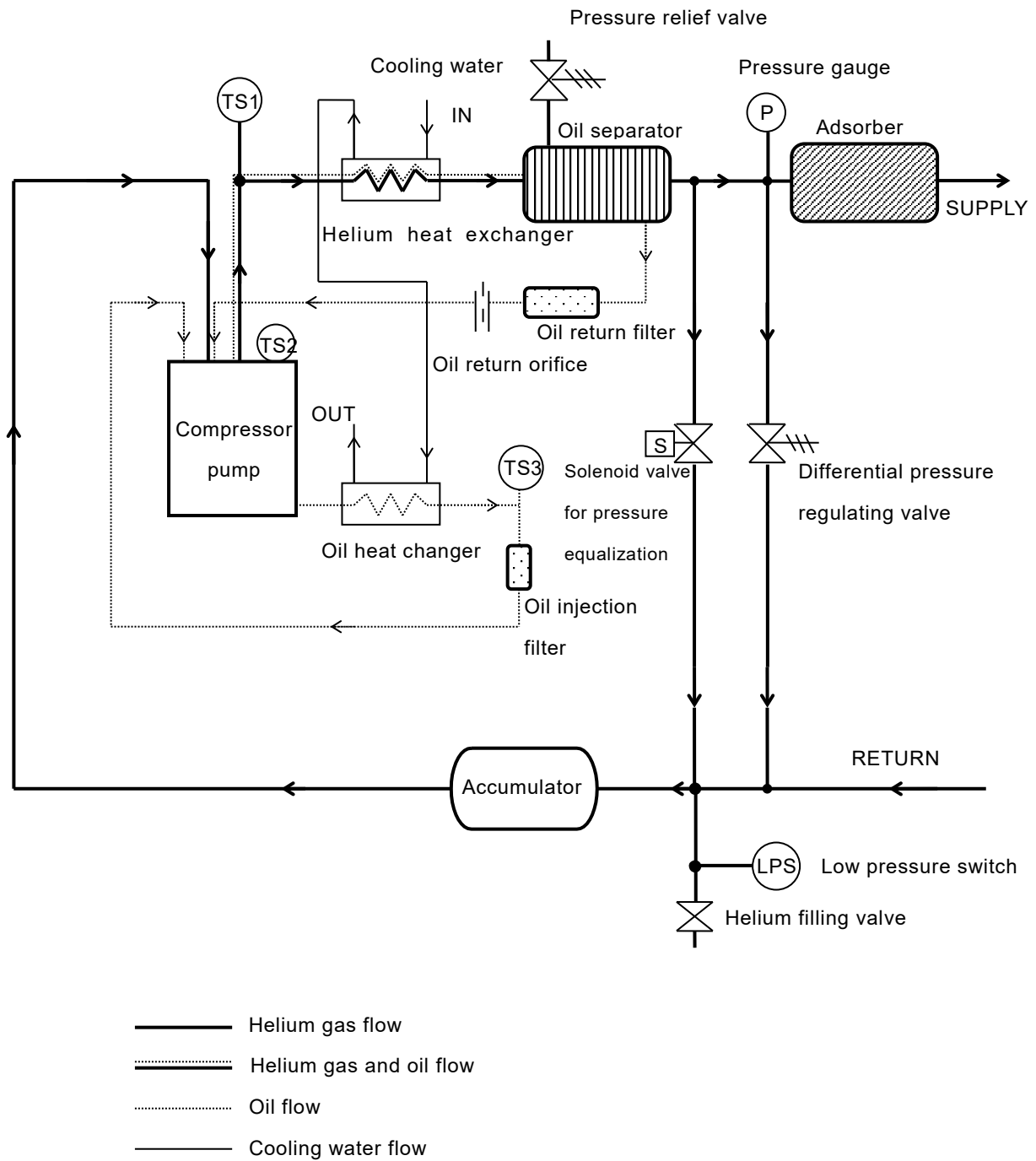


Figure D-1 Compressor flow diagram

SERVICE NETWORK

- For technical support, servicing or additional contact information, visit us at www.ulvac-cryo.com.

ULVAC CRYOGENICS INC.

www.ulvac-cryo.com

1222-1 Yabata, Chigasaki, Kanagawa 253-0085, Japan

<Sales>

Tel: +81-467-85-8884

<Service Engineering Division>

Tel: +81-467-85-9366

Fax: +81-467-83-4838

ULVAC CRYOGENICS KOREA INC.

www.ulvac-cryo.co.kr

107, Hyeongoksandan-ro, Cheongbuk-Myeon, Pyeongtaek-si,
Gyeonggi-Do, Korea, 17812

Tel: +82-31-683-2926

Fax: +82-31-683-2956

ULVAC CRYOGENICS (NINGBO) INC.

www.ulvac-cryo.com

No.888 Tonghui Road, Jiangbei District, Ningbo, China, 315020

Tel: +86-574-879-03322

Fax: +86-574-879-10707

This page intentionally left blank.

Revision History

Date	Revision No.	Contents
2006-01-17	2006.01	First edition
2006-02-03	2006FY01	The tightening torque for flexible hoses has change to 20N·m.
2006-06-01	2006JE02	Correction of error in writing.
2006-09-29	2006SR03	Correction of error in writing.
2008-06-12	2008JE04	Correction of the quantity of single handed wrench.
2008-09-24	2008SR05	P1-1 Correction of the Figure 1-1
2009-04-16	2009AL06	Section1 Table 1-2,C30MVR weight has been corrected.
2009-06-08	2009JE07	“Introduction” has been revised. “SERVICE NETWORK” has been revised.
2009-10-08	2009OR08	RM refrigerator has been added.
2010-01-15	2010JA09	Full-fledged revision.
2010-07-08	2010JU10	Carton contents have been changed.
2011-02-14	2011FY11	Cover: Export control policy has been revised.
2011-02-23	2011FY12	P.8-5 Alarm code description of CP2 has been revised.
2011-04-04	2011AL13	P.3-3 “Gasket for helium coupling (spare)” in the Table 3-1 Carton contents has been moved to the Table 3-2 Optional parts.
2011-05-11	2011MY14	P.2-4 Table 2-3 “Recommended cooling water for compressor” The unit and allowable range of Conductivity have been changed. P.7-9 Table 7-3 “Maintenance parts” has been revised.
2011-12-28	2011DR15	“SERVICE NETWORK” has been revised.
2013-03-26	2013MH16	“Safety Instruction” No.3 and No.5 have been revised. “SERVICE NETWORK” has been revised.
2013-11-08	2013NR17	“Introduction” has been revised. “SERVICE NETWORK” has been revised.
2017-01-05	2017JA18	Format has been changed. “Safety Instructions” has been modified. “Section 2.6 Remote functions” has been modified. “Section 7. Maintenance” has been revised.
2018-03-06	2018MH19	“SERVICE NETWORK” has been revised.
2022-07-04	2022JY20	“Safety Instructions” Description on the sealing sticker has been added.

2022-11-30	2022NR21	Section 1. C30VR Compressor Description Figure 1-8 has been modified.
		Section 2.4.1 Checking chemicals and quality of water The note on cooling water (Note 3) has been added.
2023-11-09	2023NR22	“Safety Instructions” Description on the adsorber disposal has been modified.
		Section 3-5 A note has been added to flexible hose specifications.
		Appendix D has been modified.
		Overall: Descriptions on end-of-sale models have been removed.